



GP20

Ultra Lite LED Projector

User Manual



# Table of contents

## **Important safety instructions ..... 3**

## **Introduction..... 6**

Projector features.....	6
Shipping contents.....	7
Projector exterior view.....	8
Controls and functions.....	9

## **Positioning your projector ..... 14**

Obtaining a preferred projected image size.....	14
---	----

## **Connection ..... 16**

Connecting the power.....	16
Connecting a computer.....	17
Connecting video source devices.....	19
Connecting an HDMI source device..	20
Connecting an MHL source device.....	21
Connecting a component video source device.....	22
Connecting a composite video source device.....	23
Connecting an external speaker.....	24
Connecting to an external memory device.....	25
Playing sound through the projector..	26

## **Operation ..... 27**

Starting up the projector.....	27
Switching input signal.....	28
Adjusting the projected image.....	29
Hiding the image.....	30
Securing the projector.....	31
Firmware upgrade.....	33

Selecting the aspect ratio.....	33
Optimizing the image.....	34
Operating in a high altitude environment.....	36
Adjusting the sound.....	36
Displaying images with PC and video source devices.....	38
Using PC/ Video pop-up menus.....	39
Displaying files with internal memory, USB drive and SD card.....	43
Using USB streaming.....	55
Using wireless streaming.....	57
Setting up Wi-Fi Network.....	68
Using settings menu.....	71
Shutting down the projector.....	77

## **Maintenance ..... 78**

Care of the projector.....	78
----------------------------	----

## **Troubleshooting..... 80**

## **Specifications..... 81**

Projector specifications.....	81
Dimensions.....	82
Timing chart.....	83

## **Warranty and Copyright information..... 87**

# Important safety instructions

Your projector is designed and tested to meet the latest standards for safety of information technology equipment. However, to ensure safe use of this product, it is important that you follow the instructions mentioned in this manual and marked on the product.

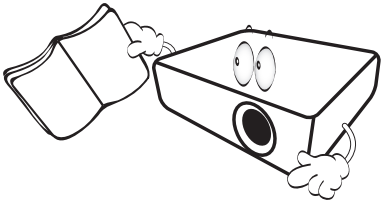
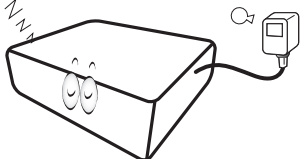
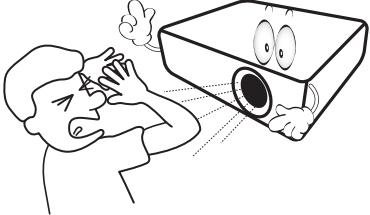
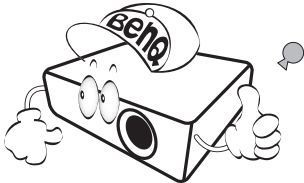
Safety Instructions	
<p>1. <b>Please read this manual before you operate your projector.</b> Save it for future reference.</p>	<p>4. In some countries, the line voltage is NOT stable. This projector is designed to operate safely within a mains voltage of 19 volts DC, but could fail if power cuts or surges of <math>\pm 10</math> volts occur. <b>In areas where the mains voltage may fluctuate or cut out, it is recommended that you connect your projector through a power stabilizer, surge protector or uninterruptible power supply (UPS).</b></p>
 <p>2. <b>Do not look straight at the projector lens during operation.</b> The intense light beam may damage your eyes.</p>	
 <p>3. <b>Refer servicing to qualified service personnel.</b></p>	<p>5. Do not block the projection lens with any objects when the projector is under operation as this could cause the objects to become heated and deformed or even cause a fire.</p>
	

## Safety Instructions (Continued)

6. Never replace any electronic components unless the projector is unplugged.

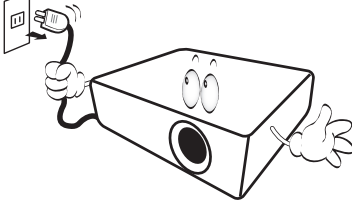

7. Do not place this product on an unstable cart, stand, or table. The product may fall, sustaining serious damage.

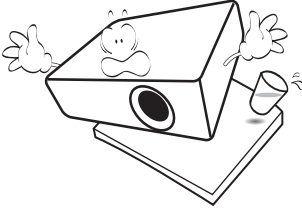

8. Do not attempt to disassemble this projector. There are dangerous high voltages inside which may cause death if you should come into contact with live parts. Refer servicing only to suitably qualified professional service personnel.

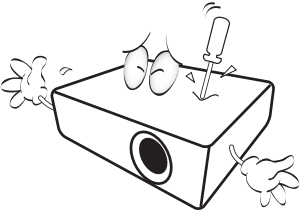

9. When the projector is under operation, you may sense some heated air and odor from its ventilation grill. It is a normal phenomenon and not a product defect.

10. Do not place this projector in any of the following environments.

- Space that is poorly ventilated or confined. Allow at least 50 cm clearance from walls and free flow of air around the projector.
- Locations where temperatures may become excessively high, such as the inside of a car with all windows rolled up.
- Locations where excessive humidity, dust, or cigarette smoke may contaminate optical components, shortening the projector's life span and darkening the image.

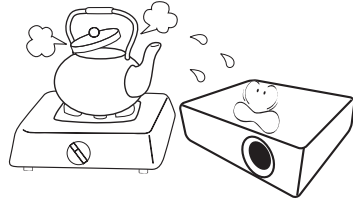

## Safety Instructions (Continued)

- Locations near fire alarms
- Locations with an ambient temperature above 40°C / 104°F
- Locations where the altitudes are higher than 3000 m (10000 feet).

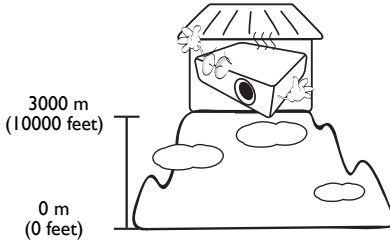

11. Do not block the ventilation holes.
- Do not place this projector on a blanket, bedding or any other soft surface.
  - Do not cover this projector with a cloth or any other item.
  - Do not place inflammables near the projector.



If the ventilation holes are seriously obstructed, overheating inside the projector may result in a fire.

12. Always place the projector on a level, horizontal surface during operation.

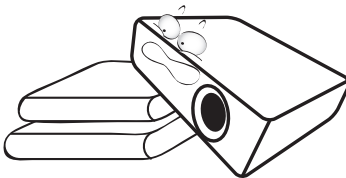

13. Do not stand the projector on end vertically. Doing so may cause the projector to fall over, causing injury or resulting in damage to the projector.

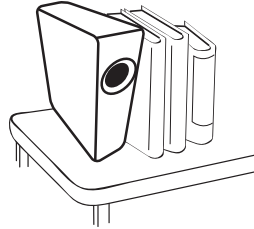

14. Do not step on the projector or place any objects upon it. Besides probable physical damage to the projector, doing so may result in accidents and possible injury.

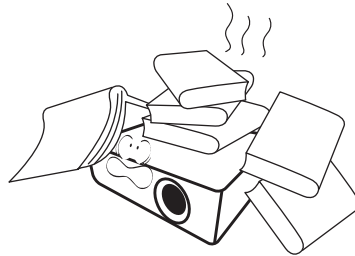

15. Do not place liquids near or on the projector. Liquids spilled into the projector may cause it to fail. If the projector does become wet, disconnect it from the power outlet and call BenQ to have the projector serviced.

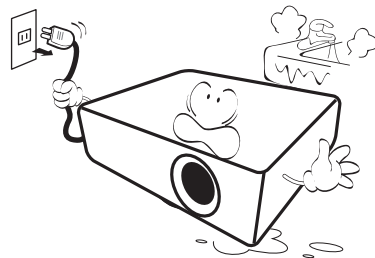

# Introduction

## Projector features

The projector integrates high-performance optical engine projection and a user-friendly design to deliver high reliability and ease of use.

The projector offers the following features.

- **Advanced LED light source**  
Long lasting LEDs provides a longer life span than traditional lamps.
- **Optical engine with DLP technologies**  
WXGA resolution and a bright picture.
- **Wireless Display**  
Supports wireless projection for PC (Windows and MAC) and mobile devices (iOS, Android).
- **SRS WOW HD™ technology**  
Significantly improves the audio playback quality with deeper bass tones and high frequency clarity for crisper detail.
- **Various useful features**  
Supports iPhone/iPad, android devices, multimedia players, document viewer, internal memory, SD card, USB flash drive, and USB display.
- **Easy to carry**  
The projector is small and light, making it useful for business trips and leisure activities. You can view documents, videos and photos anywhere.
- **Multiple input ports**  
Multiple input ports, including PC, AV, HDMI/MHL, USB, and SD card provide flexible connectivity with peripheral devices.
- **Audio input & output**  
Equipped with 3W x 2 speakers with RCA & mini-jack input ports and phone jack output port.
- **Convenient menu items**  
Friendly menu is used for all types of inputs, making the projector easy to use.
- ☞ • **The apparent brightness of the projected image will vary depending on the ambient lighting conditions, selected input signal contrast/brightness settings, and is proportional to projection distance.**
- **The lamp brightness will decline over time and may vary within the lamp manufacturers specifications. This is normal and expected behavior.**

# Shipping contents

Carefully unpack and verify that you have all of the items shown below. If any of these items are missing, please contact your place of purchase.

## Standard accessories

☞ The supplied accessories will be suitable for your region, and may differ from those illustrated.

\*The warranty card is only supplied in some specific regions. Please consult your dealer for detailed information.

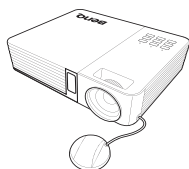

Projector

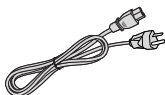

Power cord

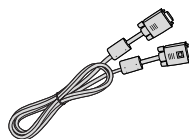

VGA cable



Quick start guide



Warranty card\*

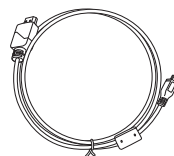

MHL cable

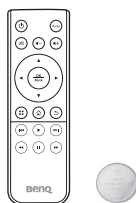

Remote control with  
battery

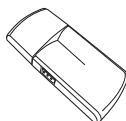

Wi-Fi dongle

☞ Pull the tab before using the remote control.

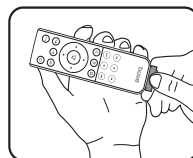

☞ User manual and wireless dongle manual are inside the projector's internal memory. You can view them directly in "Home screen/Internal memory/Document" via projector or use USB cable to link PC/notebook and projector device and choose "Home screen/USB streaming/USB File transfer". Meanwhile, the projector will be treated as external storage and you can access user manual and wireless dongle manual via PC/Notebook.

# Projector exterior view

## Front/upper side

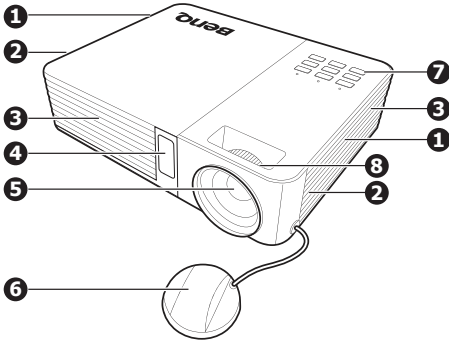

## Rear/lower side

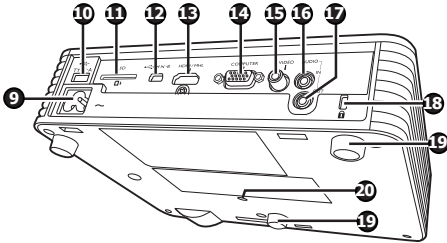

1. Vent (cold air intake)
2. Internal Speakers
3. Vent (heated air exhaust)
4. Front IR remote sensor
5. Projection lens
6. Lens cover
7. External control panel  
(See "Projector" on page 9 for details.)
8. Focus ring
9. AC power jack
10. Type A USB jack
11. SD card slot
12. Mini-B USB jack
13. HDMI / MHL input jack
14. RGB (PC)/Component Video (YPbPr/ YCbCr) signal input jack
15. Video input jack
16. Audio input jack
17. Audio output jack
18. Kensington anti-theft lock slot
19. Adjuster feet
20. Tripod socket

 **Do not block the ventilation openings. Blocking the ventilation openings can cause your projector to overheat and may cause it to fail.**



# Controls and functions

## Projector

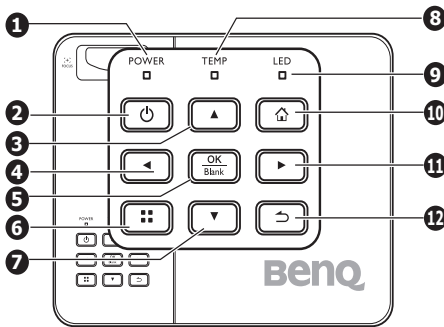

### 1. **POWER indicator light**

Lights up or flashes when the projector is under operation.

### 2. **Power**

Toggles the projector between standby mode and on.

See ["Starting up the projector" on page 27](#) and ["Shutting down the projector" on page 77](#) for details.

### 3. **Up/Volume up key**

When the On-Screen Display (OSD) menu is on:

- Navigate up to select the desired menu items.
- Make adjustments. (e.g. manual, keystone, etc.)

When the On-Screen Display (OSD) menu is off:

- Magnifies the projector volume level.

### 4. **Left key**

When the On-Screen Display (OSD) menu is on:

- Navigate left to select the desired menu items.
- Make adjustments. (e.g. brightness, contrast, etc.)

When the On-Screen Display (OSD) menu is off: (Only applied to SD card, internal memory and USB Drive)

- Play previous video and audio file.
- Press and hold to rewind video and audio file.

### 5. **OK/Blank**

Short press:

- Confirms a selected function when a menu is displayed.
- Plays or pauses a video, music, photo slideshow. (Only applied to SD card, internal memory and USB Drive)

Long press (3 seconds):

Toggles the Blank.

### 6. **Menu**

Turns on the Pop-up setting menu.

### 7. **Down/Volume down key**

When the On-Screen Display (OSD) menu is on:

- Navigate to down to select the desired menu items.
- Make adjustments. (e.g. manual, keystone, etc.)

When the On-Screen Display (OSD) menu is off:

- Reduces the projector volume level.

**8. Temperature indicator light**

Lights up red if the projector's temperature becomes too high.

**9. LED indicator light**

Indicates the status of the light source.  
Lights up or flashes when the light source has developed a problem.

**10. Home**

Directly returns to home screen from lower level of OSD.  
Exits application/pop-up message and back to home screen directly.

**11. Right key**

When the On-Screen Display (OSD) menu is on:

- Navigate right to select the desired menu items.
- Make adjustments. (e.g. brightness, contrast, etc.)

When the On-Screen Display (OSD) menu is off: (Only applied to SD card, internal memory and USB Drive)

- Play next video and audio file.
- Press and hold to fast-forward video and audio file.

**12. Back**

Goes back to previous OSD menu, exits and saves menu settings.



**Keypad functions are not available when an MHL source is selected. When using MHL as input source, please use remote control or your MHL device for operation.**

# Remote control

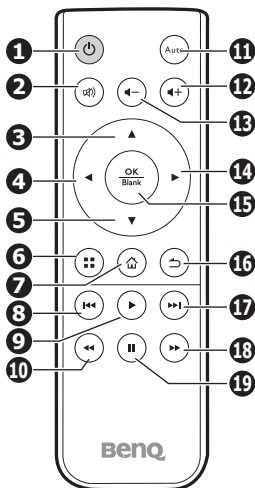

## 1. **POWER**

Toggles the projector between standby mode and on. See ["Starting up the projector" on page 27](#) and ["Shutting down the projector" on page 77](#) for details.

## 2. **Mute**

Toggles projector audio between on and off.

## 3. **Up key**

When the On-Screen Display (OSD) menu is on:

- Navigate up to select the desired menu items.
- Make adjustments. (e.g. manual keystone, etc.)

When the On-Screen Display (OSD) is off:

- Magnifies the projector volume level.

## 4. **Left key**

When the On-Screen Display (OSD) menu is on:

- Navigate left to select the desired menu items.
- Make adjustments. (e.g. brightness, contrast, etc.)

When the On-Screen Display (OSD) menu is off: (Only applied to SD card, internal memory and USB Drive)

- Plays previous video, music, photo slideshow or document.
- Press and hold to rewind video and audio file.

## 5. **Down key**

When the On-Screen Display (OSD) menu is on:

- Navigate to down to select the desired menu items.
- Make adjustments. (e.g. manual keystone, etc.)

When the On-Screen Display (OSD) is off:

- Reduces the projector volume level.

## 6. **Menu**

Turns on or off the Pop-up setting menu.

## 7. **Home**

Directly returns to home screen from lower level of OSD.

Exits application/pop-up message and back to home screen directly.

## 8. **Prev.**

Plays previous video, audio, photo slideshow or document file. (Only applied to SD card, internal memory, USB Drive and MHL)

## 9. **Play**

Plays or pauses video, music or photo slideshow. (Only applied to SD card, internal memory, USB Drive and MHL)

#### 10. **Rewind**

Rewinds video and audio file. (Only applied to SD card, internal memory, USB Drive and MHL)

#### 11. **Auto**

Automatically determines the best picture timings for the displayed computer image. See "[Auto-adjusting the image](#)" on page 29 for details.

#### 12. **Volume up key**

Magnifies the volume level.

#### 13. **Volume down key**

Reduces the volume level.

#### 14. **Right Key**

When the On-Screen Display (OSD) menu is on:

- Navigate right to select the desired menu items.
- Make adjustments. (e.g. brightness, contrast, etc.)

When the On-Screen Display (OSD) menu is off: (Only applied to SD card, internal memory and USB Drive)

- Plays next video, music, photo slideshow or document.
- Press and hold to fast-forward video and audio file.

#### 15. **OK/Blank**

Short press:

- Confirms a selected function when a menu is displayed.
- Plays or pauses video, music, or photo slide show. (Only applied to SD card, internal memory and USB drive)

Long press (3 seconds):

- Toggles Blank on and off. See "[Hiding the image](#)" on page 30 for details.

#### 16. **Back**

Returns to upper level of OSD.

Closes pop-up setting menu of OSD.

Returns to home screen.

Leave current application of OSD.

#### 17. **Next**

Plays next video, audio, photo slideshow or document. (Only applied to SD card, internal memory, USB Drive and MHL)

#### 18. **Fast-forward**

Fast-forwards video and audio file. (Only applied to SD card, internal memory, USB Drive and MHL)

#### 19. **Pause**

Pauses video and audio file. (Only applied to SD card, internal memory, USB Drive and MHL)



**Certain remote control functions might not work under MHL operation because the MHL device being used may not support these functions. Please check your MHL device for available functions.**

## Remote control effective range

Infra-Red (IR) remote control sensor is located on the front of the projector. The remote control must be held at an angle within 15 degrees perpendicular to the projector's IR remote control sensor to function correctly. The distance between the remote control and the sensor should not exceed 7 meters (~ 23 feet).

Make sure that there are no obstacles between the remote control and the IR sensor on the projector that might obstruct the infra-red beam.

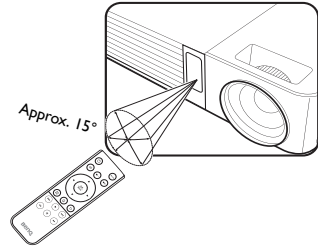

## Replacing the remote control battery

1. Pull out the battery holder.

 Please follow the illustrated instructions. Push and hold the locking arm while pulling out the battery holder.

2. Insert the new battery in the holder. Note the positive polarity should face outward.

3. Push the holder into the remote control.



• **Avoid excessive heat and humidity.**

• **There may be battery damage if the battery is incorrectly replaced.**

• **Replace only with the same or equivalent type recommended by the battery manufacturer.**

• **Dispose of the used battery according to the battery manufacturer's instructions.**

• **Never throw battery into a fire. There may be danger of an explosion.**

• **If the battery is dead or if you do not plan to use the remote control for a long time, remove the battery to prevent damage to the remote control from possible battery leakage.**

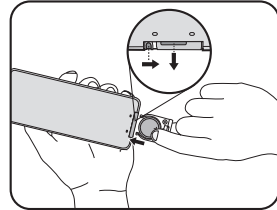

# Positioning your projector

## Obtaining a preferred projected image size

The distance from the projector lens to the screen, the zoom setting (if available), and the video format each factors in the projected image size.

16:10 is the native aspect ratio of this projector.

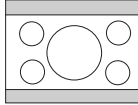

16:10 aspect image scaled to a 4:3 aspect display area

The projector should always be placed horizontally level (like flat on a table), and positioned directly perpendicular (90° right-angle square) to the horizontal center of the screen. This prevents image distortion caused by angled projections (or projecting onto angled surfaces).

The modern digital projector does not project directly forward (like older style reel-to-reel film projectors did). Instead, digital projectors are designed to project at a slightly upward angle above the horizontal plane of the projector. The projector can be readily placed on a table, and the position of its projection will be forward and upward on a screen so the bottom edge of the screen is above the level of the table (and everyone in the room can see the screen).

If the projector is positioned further away from the screen, the projected image size increases, and the vertical offset also increases proportionately.

When determining the position of the screen and projector, you will need to account for both the projected image size and the vertical offset dimension, which are proportional to the projection distance.

BenQ has provided a table of screen size to assist you in determining the ideal location for your projector. Refer to ["Projection dimensions" on page 15](#) for details. There are two dimensions to consider, the perpendicular horizontal distance from the center of the screen (projection distance), and the vertical offset height of the projector from the horizontal edge of the screen (offset).

# Projection dimensions

Refer to "Dimensions" on page 82 for the center of lens dimensions of this projector before calculating the appropriate position.

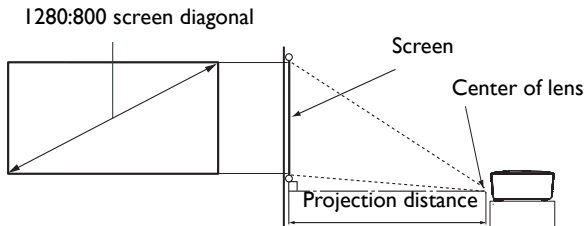

Screen Size				Projection distance in mm
Diagonal		W (mm)	H (mm)	
Inches	mm			
30	762	646	404	750
40	1016	862	538	1000
50	1270	1077	673	1250
60	1524	1292	808	1500
80	2032	1723	1077	2000
100	2540	2154	1346	2500
120	3048	2585	1615	3000
150	3810	3231	2019	3750
200	5080	4308	2692	5000
220	5588	4739	2962	5500
250	6350	5385	3365	6250
300	7620	6462	4039	7500

 All measurements are approximate and may vary from the actual sizes. BenQ recommends that if you intend to permanently install the projector, you should physically test the projection size and distance using the actual projector in situ before you permanently install it, so as to make allowance for this projector's optical characteristics. This will help you determine the exact mounting position so that it best suits your installation location.

# Connection

 In the connections shown below, some cables may not be included with the projector (see "Shipping contents" on page 7). They are commercially available from electronics stores.

## Connecting the power

1. Insert one end of the provided power cord into the AC IN terminal.
2. Insert the plug on the power cord into a power outlet. Check that the Power LED indicator on the projector lights orange when using the AC adapter.

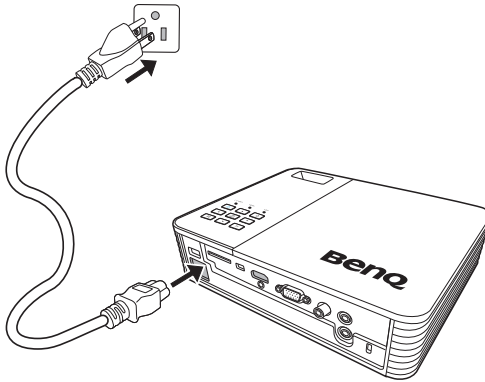



# Connecting a computer

The projector provides a VGA input socket that allows you to connect it to both IBM® compatibles and Macintosh® computers. A Mac adapter is needed if you are connecting legacy version Macintosh computers.

## To connect the projector to a notebook or desktop computer:

- Using a VGA cable
1. Take the supplied VGA cable and connect one end to the D-Sub output socket of the computer.
  2. Connect the other end of the VGA cable to the **COMPUTER** socket on the projector.
  3. If you wish to make use of the projector speaker, take a suitable audio cable and connect one end of the cable to the audio output socket of the computer, and the other end to the audio input socket on the projector.

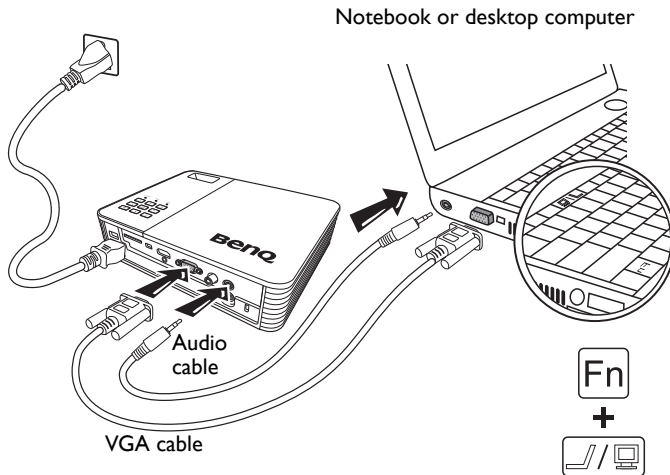

**Many notebooks do not turn on their external video ports when connected to a projector. Usually a key combo like FN + F3 or CRT/LCD key turns the external display on/off. Locate a function key labeled CRT/LCD or a function key with a monitor symbol on the notebook. Press FN and the labeled function key simultaneously. Refer to your notebook's documentation to find your notebook's key combination.**

- Using an HDMI cable

1. Take an HDMI cable and connect one end to the HDMI output jack of the computer.
2. Connect the other end of the HDMI cable to the HDMI jack on the projector.

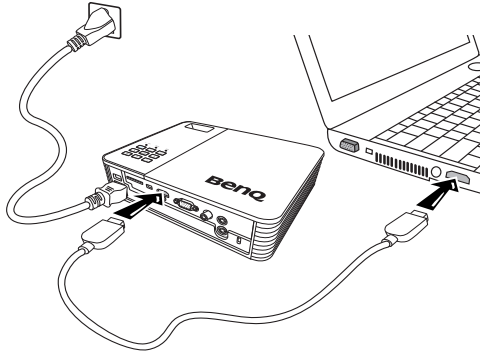

- Using a USB cable

1. Take a USB cable and connect the type A end to the USB output jack of the computer.
2. Connect the mini-B type end of the USB cable to the mini-B USB jack on the projector. When you connect the projector to a computer, you can display computer's image or transfer files from your computer to the internal memory of the projector.

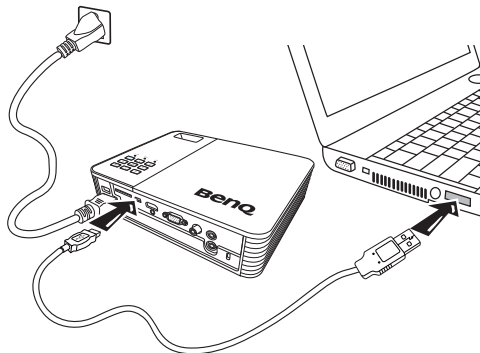

3. If you select USB Display, follow the on-screen message to install the USB driver in your computer first.
4. If you select USB File Transfer, go to My Computer or Windows Explorer to access the projector's files. The projector appears as a Removable Disk. Transfer the files from your computer to the projector by dragging and dropping or copying and pasting.

To disconnect the projector from a computer:

- i. Click  on the Windows Taskbar.
- ii. Click the pop-up message.

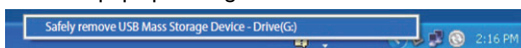



iii. Disconnect the USB cable only when the message says it is safe to remove the hardware.

- ☞ **Do not disconnect the USB cable while the files are being copied, as this could result in loss of data or damage to the projector.**
- **The connection will not end if you have projector files open on the computer. Close all projector files and try again.**
- **Other versions of Windows operate similarly. Follow the correct procedure for removing a USB device from your computer safely for your version of Windows.**

## Connecting video source devices

You only need to connect the projector to a video source device using just one of the above connecting methods; however, each provides a different level of video quality. The method you choose will most likely depend upon the availability of matching terminals on both the projector and the video source device as described below:

Terminal name	Terminal appearance	Picture quality
HDMI / MHL	HDMI / MHL 	Best
Component Video	VGA 	Better
Video	Video 	Good

- ☞ **If the selected video image is not displayed after the projector is turned on and the correct video source has been selected, check that the video source device is turned on and operating correctly. Also, check and confirm that the signal cables have been connected correctly.**

# Connecting an HDMI source device

The projector provides an HDMI input jack that allows you to connect it to an HDMI source device like a Blu-Ray player, a DTV tuner or a display.

HDMI (High-Definition Multimedia Interface) supports uncompressed video data transmission between compatible devices like DTV tuners or Blu-Ray player, and transmits signal over a single cable. It provides pure digital viewing and listening experience.

Examine your video source device to determine if it has a set of unused HDMI output jacks available:

- If so, you can continue with this procedure.
- If not, you will need to reassess which method you can use to connect to the device.

## To connect the projector to an HDMI source device:

1. Take an HDMI cable and connect one end to the HDMI output jack of the HDMI source device.
2. Connect the other end of the HDMI cable to the **HDMI** jack on the projector.

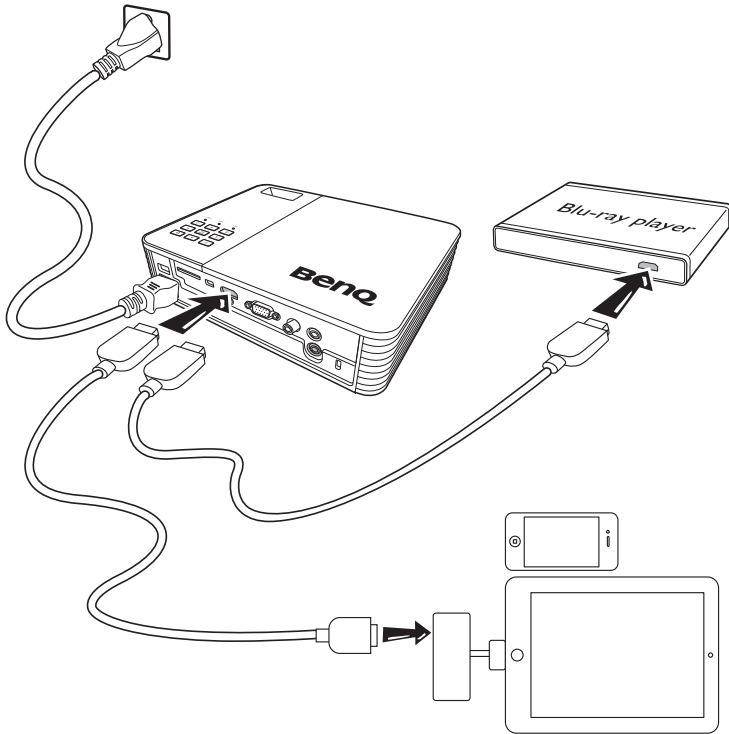

-  The HDMI cable (shown in this example) for connecting your video output device is not supplied as standard accessory.
- The Apple Digital AV Adapter can be purchased from [www.apple.com](http://www.apple.com).

# Connecting an MHL source device

This projector supports MHL devices (MHL-enabled) through the use of HDMI input jack. You can connect your MHL-enabled mobile device to the projector with an MHL cable to play high-definition video with fluidity.

MHL (Mobile High-definition Link) supports uncompressed HD video (1080/30p) and audio (7.1 surround sound) transmission between compatible devices like mobiles phones, tablets and other portable consumer electronics devices and transmits signal over a single cable. It provides pure digital viewing and listening experience.

Examine your mobile device to determine if it is MHL-enabled:

- If so, you can continue with this procedure.
- If not, you will need to reassess which method you can use to connect to the device.

## To connect the projector to an MHL source device:

1. Take an MHL cable and connect the MHL end to the MHL output jack of the MHL source device.
2. Connect the HDMI end of the MHL cable to the **HDMI/MHL** jack on the projector.

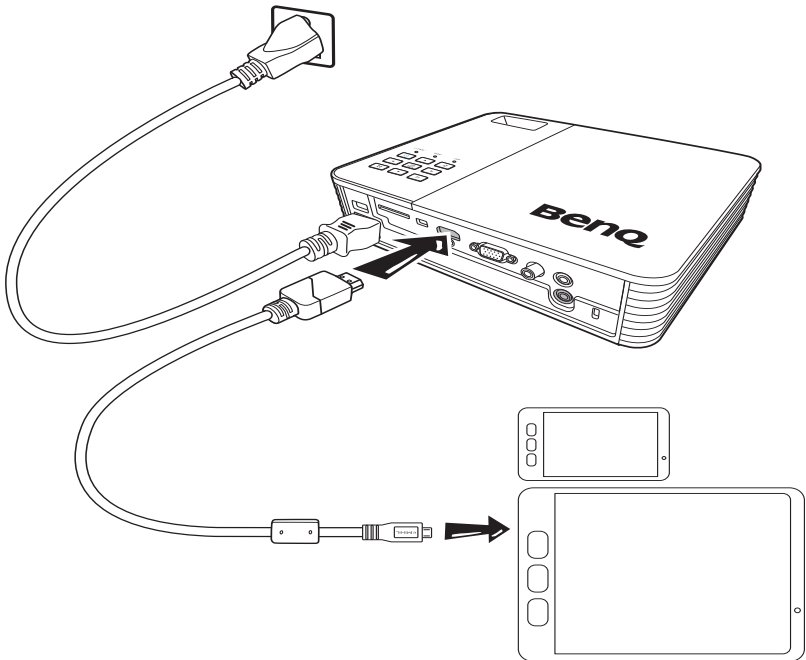

-  • **Not all mobile devices are MHL-enabled, consult with your mobile device dealer to verify MHL capabilities.**

# Connecting a component video source device

Examine your video source device to determine if it has a set of unused component video output sockets available:

- If so, you can continue with this procedure.
- If not, you will need to reassess which method you can use to connect to the device.

## To connect the projector to a component video source device:

1. Take a component video to VGA (D-Sub) adaptor cable and connect the end with 3 RCA type connectors to the component video output sockets of the video source device. Match the color of the plugs to the color of the sockets; green to green, blue to blue, and red to red.
2. Connect the other end to the **COMPUTER** socket on the projector.
3. If you wish to make use of the projector speaker, take a suitable audio cable and connect one end of the cable to the audio output sockets of the video source device, and the other end to the audio input socket on the projector.

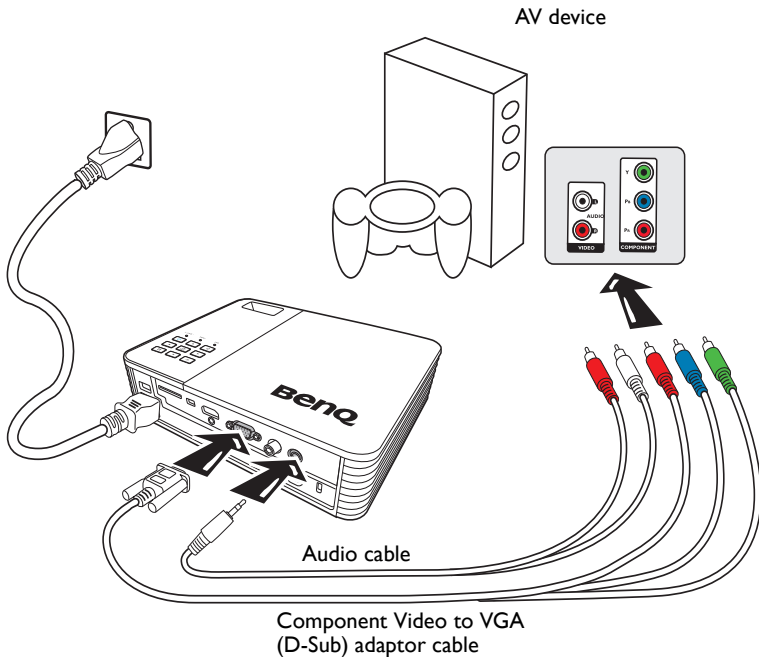

- ☞ • **When audio output jack is connected with the earphone or external speaker, the sound will not come out from the projector speaker.**
- **No sound will come out from the speaker or audio output jack if video signals are not input. Besides, the sound cannot be adjusted either.**

# Connecting a composite video source device

Examine your video source device to determine if it has a set of unused composite video output sockets available:

- If so, you can continue with this procedure.
- If not, you will need to reassess which method you can use to connect to the device.

## To connect the projector to a composite video source device:

1. Take a video cable and connect one end to the composite video output socket of the video source device.
2. Connect the other end of the video cable to the **VIDEO** jack on the projector.
3. If you wish to make use of the projector speaker, take a suitable audio cable and connect one end of the cable to the audio output sockets of the video source device, and the other end to the audio input socket on the projector.

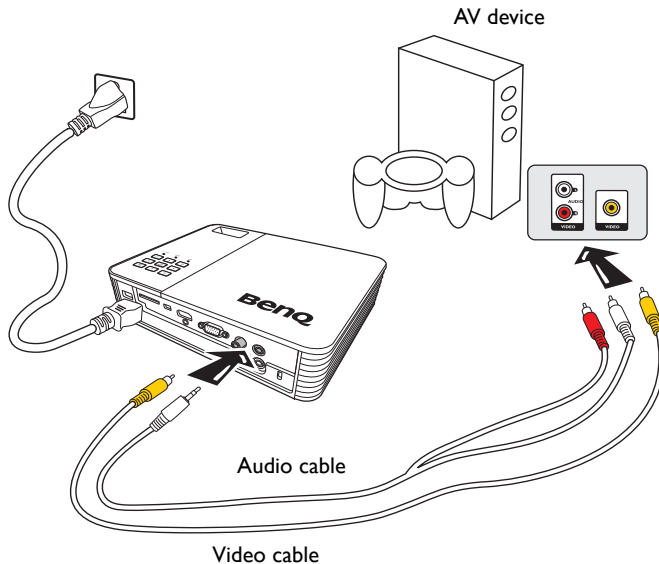

 You need only to connect this device with a composite video cable if component video input is unavailable. See "[Connecting video source devices](#)" on page 19 for details.

# Connecting an external speaker

You can hear sound through an external speaker instead of the internal speakers built into the projector.

## To connect the projector to an external speaker source device:

1. Connect an appropriate stereo cable to the external speaker and the audio output jack on the projector.

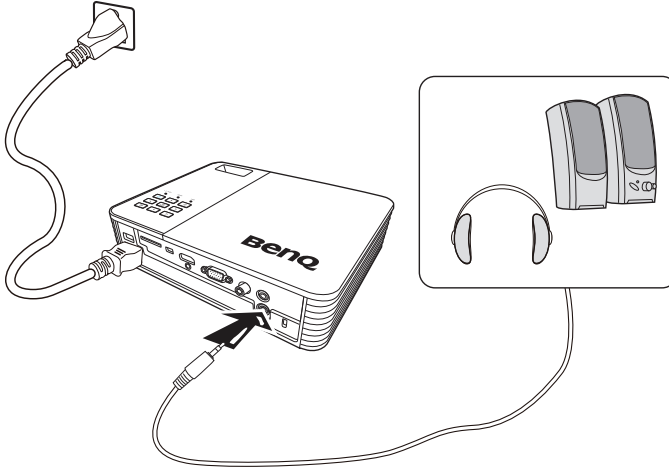

 **When the audio cable is connected to the audio output jack, the internal speaker is muted.**



# Connecting to an external memory device

## Connecting an SD card

**To connect the projector to an SD card:**

Connect an SD card to the SD card slot on the projector.

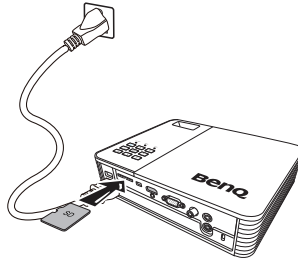

- The maximum memory capacity supported for an SD(HC) card is 32 GB. (The maximum capacity supported for external memory is based on our factory test. Your experience may differ depending on the manufacturer of the memory device.)
- The projector may not be compatible with some SD cards.

## Connecting a USB storage device

**To connect the projector to a USB storage device:**

Plug the USB storage device into the Type A USB socket.

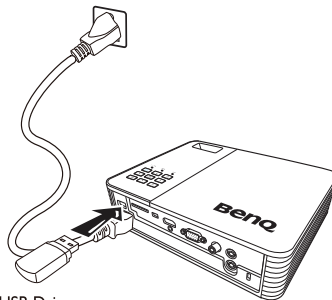

USB Drive  
(USB flash drive)



- This product supports **USB** memory device and **HDD (Hard Disk Drive)**. Only the partition that was most recently used will be mounted. (The maximum capacity supported for external memory is based on our factory test. Your experience may differ depending on the manufacturer of the memory device.)
- The **Type A USB** port provides up to 500 mA of power for HDDs when connected to this projector. In the event that large capacity HDDs cannot be read by this projector, it may be due to insufficient power. In this case, connect the HDD to an external power source with a Y-type USB cable to provide HDD with extra power.
- This product does not support multi-card readers.
- This product does not work if the **USB** storage device is connected by a **USB HUB**.
- Products that do not comply with standard **USB** specifications might not operate normally.

- **A USB storage device with an automatic recognition application or its own driver might not operate normally.**
- **A USB storage device that uses only a designated driver might not be recognized.**
- **Recognition speed for USB storage device may vary by device.**
- **Do not turn off the product or pull a connected USB storage device out while the USB storage device is in use. Doing so may result in damage to the USB storage device or stored file.**
- **Use a USB storage device which contains normal files. Abnormal files can cause a malfunction or the files may not play.**
- **USB storages must be formatted in FAT16/FAT32/NTFS. FAT32 and NTFS are recommended for HDD (Hard Disk Drive).**
- **As the data in the USB storage device can be damaged, please back up important data to avoid loss. The user is responsible for data management. BenQ shall not be held liable for any data loss.**
- **File tree in USB storage should be as simple as possible. Too many or too many layers of folders will result in lag of access time.**
- **If an external memory device does not operate after you have connected it to the projector, try to connect it to a PC. If it still does not operate normally, contact the memory device manufacturer service center or related customer center.**

## Playing sound through the projector

You can make use of the projector speaker in your presentations, and also connect separate amplified speakers to the audio output jack of the projector.

The table below describes the connection methods for different devices, and where the sound is from.

Device	PC/Component video	Video
Audio input jack	Audio input (L/R) AUDIO-IN	Audio input (L/R)
The projector can play the sound from...	Audio input (L/R) AUDIO-IN	Audio input (L/R)
Audio output jack		

- **The selected input signal determines which sound will be played by the projector speaker, and which sound will be output from the projector when audio output jack is connected.**
- **There's no need to connect to an audio input jack because the projector can play the sound from an HDMI / MHL, external memory and iPhone/iPad source device. However, you can connect to an external device to play the sound.**
- **USB display does not support audio function.**

# Operation

## Starting up the projector

1. Connect the power using the power cord. The Power indicator turns into orange.
2. Press **Power** on the projector or remote control to start the projector. The Power indicator lights green when the projector is on.

The start up procedure takes several seconds. In the later stage of start up, a startup logo is projected.

(If necessary) Rotate the focus ring to adjust the image clearness.

3. If the projector is activated for the first time, select your OSD language following the onscreen instructions.
4. If you are prompted for a password, press the arrow keys to enter a six digit password. See ["Utilizing the password function" on page 31](#) for details.
5. Switch all of the connected equipment on.
6. The projector will display the home screen.

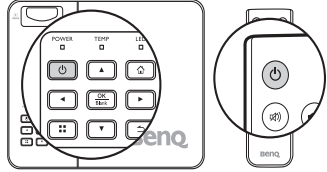

 **If the frequency/resolution of the input signal exceeds the projector's operating range, you will see the message 'Out of Range' displayed on a blank screen.**

**Please change to an input signal which is compatible with the projector's resolution or set the input signal to a lower setting. See ["Timing chart" on page 83](#) for details.**



# Switching input signal

## Selecting an input source

The projector can be connected to multiple devices at the same time. However, it can only display one full screen at a time. Press ◀/▶ on the projector or remote control to select your desired input signal.

- ☞ • The input signal type affects the options available for the Picture Mode. See "[Selecting a picture mode](#)" on page 34 for details.

- The native display resolution of this projector is in 16:10 aspect ratio. For best display picture results, you should select and use an input signal outputting at this resolution. Any other resolutions will be scaled by the projector depending upon the 'aspect ratio' setting, and this may result in image distortion or loss of picture clarity. See "[Selecting the aspect ratio](#)" on page 33 for details.

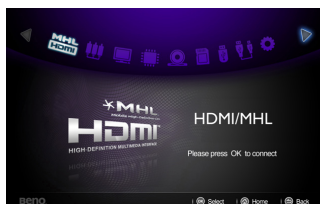

## Setting quick auto search

To set your projector to automatically search for input signals:

1. Go to **Settings > Basic > Quick Auto Search** menu, press **OK**, and a pop-up menu appears.
2. Select **On** and press **OK**.
3. To leave the OSD menu, press ↶ or ↷.

## Changing color space

In the unlikely event that you connect the projector to a DVD player via the projector's HDMI input and the projected picture displays wrong colors, please change the color space to YUV.

1. Press ⏏ and press ▼ to highlight **Color Space Conversion** and press **OK**, a pop-up menu appears.
2. Select a suitable color space and press **OK**.

- ☞ • This function is only available when the HDMI input port is in use.

# Adjusting the projected image

## Adjusting the image height

The projector is equipped with 2 adjuster feet. These adjusters change the image height. To adjust the projector:

- Screw the adjuster feet to adjust the image height.
- To retract the feet, screw the adjuster feet in reverse direction.

If the projector is not placed on a flat surface or the screen and the projector are not perpendicular to each other, the projected image becomes trapezoidal. To correct this situation, see "[Correcting keystone](#)" on page 30 for details.

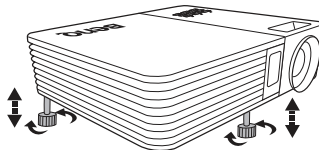

- ⚠ **Do not look into the lens while the lamp is on. The strong light from the lamp may cause damage to your eyes.**
- **Be careful when you screw the adjuster foot as it is close to the exhaust vent where hot air comes from.**

## Fine-tuning the image clarity

Rotate the focus ring to sharpen the image.

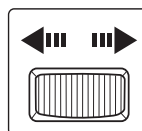
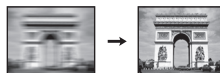

## Auto-adjusting the image

In some cases, you may need to optimize the picture quality.

- Using the remote control

Press **AUTO**.

Within 3 seconds, the built-in Intelligent Auto Adjustment function will re-adjust the values of Frequency and Clock to provide the best picture quality.

The current source information will be displayed on the upper left corner of the screen for 3 seconds.

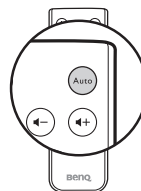

☞ **This function is only available when PC signal (analog RGB) is selected.**

## Correcting keystone

Keystoning refers to the situation where the projected image is noticeably wider at either the top or bottom. It occurs when the projector is not perpendicular to the screen. Correcting keystone when an image is displayed on the screen

To correct this, besides adjusting the height of the projector, you will need to manually correct it following these steps.

1. Press **⏏** and then press **▼** to highlight **Keystone**. The **Keystone** pop-up menu displays.
2. Press **▲** to correct keystone at the bottom of the image or press **▼** to correct keystone at the top of the image.

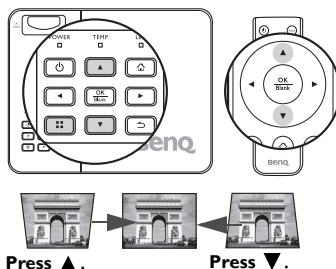

## Hiding the image

In order to draw the audience's full attention to the presenter, you can:

- Using the remote control  
Press and hold **Blank** for three seconds on the remote control to hide the screen image. Press **Blank** again or any keys on the remote control to restore the image.
- Using the projector  
Press and hold **Blank** for 3 seconds on the projector to hide the screen image. Press **Blank** again or any keys on the projector to restore the image.



**Do not block the projection lens from projecting as this could cause the blocking object to become heated and deformed or even cause a fire.**

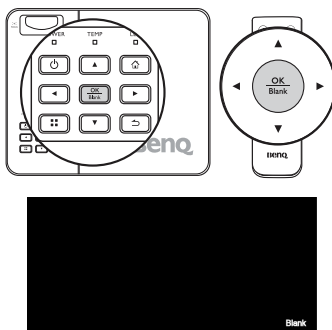

# Securing the projector

## Utilizing the password function

For security purposes and to help prevent unauthorized use, the projector includes an option for setting up password security. The password can be set through the Settings menu.

 **You will be inconvenienced if you activate the power-on lock functionality and subsequently forget the password. Print out this manual (if necessary), write the password you used in this manual and keep the manual in a safe place for later recall.**

## Setting power on lock

-  • **Once a password has been set, the projector cannot be used unless the correct password is entered every time the projector is started.**
- **When setting a password for the projector with its password function being used for the first time, enter the default password (1, 1, 1, 1, 1, 1) of the projector by pressing the ▲ arrow key six times if you are prompted for a password.**
1. Press ◀/▶ until the **Settings** menu is highlighted and then press **OK** to enter.
  2. Go to the **Advanced > Security Settings > Change Security Settings** menu.
  3. Press **OK**. The message **“Input Current Password”** appears.
  4. As pictured to the right, the four arrow keys (▲, ▶, ▼, ◀) respectively represent 4 digits (1, 2, 3, 4). Press the arrow keys to enter six digits for the password.
  5. Once the correct password is set, the OSD menu returns to the **Change Security Settings** menu.
  6. Highlight **Power on Lock** and press **OK**. The pop-up menu appears. Select **On** and press **OK** to complete power on lock setting.
  7. To leave the OSD menu, press ⇨ or ⇩.

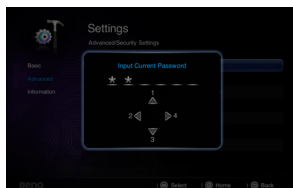

## If you forget the password

If the password function is activated, you will be asked to enter the six-digit password every time you turn on the projector. If you enter the wrong password, the password error message displays for three seconds, and the message **“Input Password”** follows. If you enter an incorrect password 5 times in succession, the projector will automatically shut down in a short time.

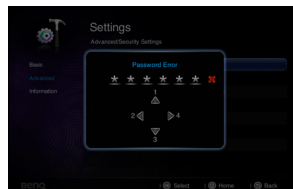

## Entering the password recall procedure

1. Press and hold **⏏** on the remote control for 3 seconds. The projector will display a coded number on the screen.
2. Write down the number and turn off your projector.
3. Seek help from your local BenQ service center to decode the number. You may be required to provide proof of purchase documentation to verify that you are an authorized user of the projector.

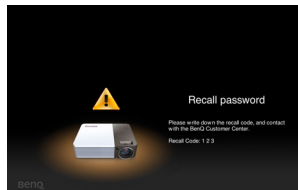

## Changing the password

1. Go to the **Settings > Advanced > Security Settings > Change password** menu.
2. Press **OK**. The message **"Input Current Password"** appears.
3. Enter the old password.
  - If the password is correct, another message **"Input New Password"** appears.
  - If the password is incorrect, the password error message displays for three seconds, and the message **"Input Current Password"** displays for you to retry. You can press **↵** to cancel the change or try another password.
4. Enter a new password.

 The digits being input will display as asterisks on-screen. Write your selected password down in this manual in advance or right after the password is entered so that it is available to you should you ever forget it.

**Password:** \_\_\_\_\_

**Keep this manual in a safe place.**

5. Confirm the new password by re-entering the new password.
6. You have successfully assigned a new password to the projector. Remember to enter the new password next time the projector is started.
7. To leave the OSD menu, press **↵** or **⏏**.

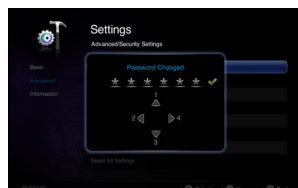

## Disabling the password function

To disable password protection, go to **Settings > Advanced > Security Settings > Power on Lock** menu. Select **Off** and press **OK**. The message **"Input Password"** appears. Enter the current password.

- If the password is correct, the OSD menu returns to the **Security Settings** page with **"Off"** shown in the row of **Power on Lock**. You will not have to enter the password next time you turn on the projector.
- If the password is incorrect, the password error message displays for three seconds, and the message **"Input Password"** displays for you to retry. You can press **↵** to cancel the change or try another password.



☞ Though the password function is disabled, you need to keep the old password in hand should you ever need to re-activate the password function by entering the old password.

## Firmware upgrade

Follow below procedures to upgrade firmware version.



- ☞
- Only an SD Card is supported for firmware update.
  - Do not remove the SD Card while an update is in progress.
  - Do not operate any buttons during the update.
  - Do not turn the projector off during the update.
  - To confirm that the firmware has been successfully updated, go to **Settings > Information > Firmware version**.

## Updating the firmware

1. Connect the SD card containing the latest firmware to the projector.
2. Select **Settings > Advanced > Firmware Upgrade** in the main menu page.
3. Select **OK** to begin.
4. After the firmware is updated, please turn off the projector.
5. Power on the projector and check the firmware version.

## Selecting the aspect ratio

The 'aspect ratio' is the ratio of the image width to the image height. Most analog TV and computers are in 4:3 ratio, which is the default for this projector, and digital TV and DVDs are usually in 16:9 ratio.

With the advent of digital signal processing, digital display devices like this projector can dynamically stretch and scale the image output to a different aspect than that of the image input signal.

To change the projected image ratio (no matter what aspect the source is):

1. Press **⏏** to open the pop-up menu in one of the computer, composite video, component and HDMI/MHL modes.
2. Press **▼** to highlight Aspect Ratio.
3. Press **◀/▶** to select an aspect ratio to suit the format of the video signal and your display requirements.

# Optimizing the image

## Selecting a picture mode

The projector is preset with several predefined picture modes so you can choose one to suit your operating environment and input signal picture type.

To select an operation mode that best suits your need, you can follow the following steps.

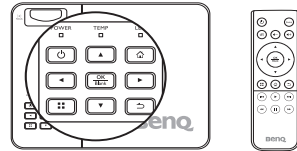

- Make sure the input source is on computer, composite video, component or HDMI/MHL mode and the projection screen is being displayed.
- You may press **Menu** to open the pop-up menu. Press **Down** to select **Picture Mode Settings** and press **OK** to enter. Select **Picture Mode** and press **Left/Right** to select a desired mode.

The picture modes are listed below.

1. **Bright mode:** Maximizes the brightness of the projected image. This mode is suitable for environments where extra-high brightness is required, such as using the projector in well lit rooms.
2. **Standard mode (Default):** Is designed for presentations. The brightness is emphasized in this mode.
3. **Cinema mode:** Is appropriate for playing colorful movies, video clips from digital cameras or DVs through the PC input for best viewing in a blackened (little light) environment.
4. **Game mode:** Is appropriate for playing games.
5. **User mode:** Recalls the settings customized based on the current available picture modes. See "[Setting the User mode](#)" for details.

## Setting the User mode

There is an user-definable mode if the current available picture modes are not suitable for your need. You can use one of the picture modes (except the **User**) as a starting point and customize the settings.

1. Press **Menu** to open the pop-up menu.
2. Press **Down** to select **Picture Mode Settings** and press **OK** to enter.
3. Select **Picture Mode** and press **Left/Right** to select **User**.
4. Press **Down** to highlight **Reference Mode**.

 This function is only available when **User mode** is selected in the **Picture Mode** sub-menu.

5. Press **Left/Right** to select a picture mode that is closest to your need.
6. Press **Down** to select a sub-menu item to be changed and adjust the value with **Left/Right**. See "[Fine-tuning the image quality in User mode](#)" on page 35 for details.
7. When all settings have been done, highlight **Save Settings** and press **OK** to store the settings.
8. The confirmation message "**Setting Saved**" appears.

## Using Wall Color

In the situation where you are projecting onto a colored surface such as a painted wall which may not be white, the Wall Color feature can help correct the projected picture's color to prevent possible color difference between the source and projected pictures.

To use this function, press **■** to open the pop-up menu in one of the computer, iPhone/iPad, composite video, component and HDMI/MHL modes. Select **Wall Color** and press **◀ / ▶** to select a color which is closest to the color of the projection surface. There are several precalibrated colors to choose from: Light Yellow, Pink, Light Green, Blue, and Blackboard.

## Fine-tuning the image quality in User mode

According to the detected signal type, there are some user-definable functions available when User mode is selected. Based on your needs, you can make adjustments to these functions by highlighting them and pressing **◀ / ▶** on the projector or remote control.

### Adjusting Brightness

The higher the value, the brighter the image. And the lower the setting, the darker the image. Adjust this control so the black areas of the image appear just as black and that detail in the dark areas is visible.



### Adjusting Contrast

The higher the value, the greater the contrast. Use this to set the peak white level after you have previously adjusted the **Brightness** setting to suit your selected input and viewing environment.



### Adjusting Color

Lower setting produces less saturated colors. If the setting is too high, colors on the image will be overpowering, which makes the image unrealistic. Color is only adjustable under analog video sources such as composite video and component video sources.

### Adjusting Tint

The higher the value, the more reddish the picture becomes. The lower the value, the more greenish the picture becomes. Tint is only adjustable under video and S-video sources with video signal in NTSC or SECAM format.

### Adjusting Sharpness

The higher the value, the sharper the picture becomes. The lower the value, the softer the picture becomes. Sharpness is only adjustable under analog video sources such as composite video and component video sources.

### Selecting a Color Temperature

There are a number of options available for color temperature\* settings which vary according to the signal type selected.

#### \*About color temperatures:

There are many different shades that are considered to be "white" for various purposes. One of the common methods of representing white color is known as the "color temperature". A white color with a low color temperature appears to be reddish white. A white color with a high color temperature appears to have more blue in it.

# Operating in a high altitude environment

We recommend you use the **High Altitude Mode** when your environment is between 1500 m –3000 m above sea level and the ambient temperature is between 0°C–30°C.



**Do not use the High Altitude Mode if your altitude is between 0 m and 1499 m and ambient temperature is between 0°C and 35°C. The projector will be over cooled if you turn the mode on under such a condition.**

To activate the **High Altitude Mode**:

1. Highlight **Settings** and press **OK** to enter.
2. Go to **Advanced > High Altitude Mode** and press **OK**.
3. Highlight **On** and press **OK** to confirm.
4. To leave the OSD, press  $\rightarrow$  until the projector returns to the home screen, or press  $\uparrow$  to go back to the home screen directly.

Operation under "**High Altitude Mode**" may cause a higher decibel operating noise level because of increased fan speed necessary to improve overall system cooling and performance.

If you use this projector under other extreme conditions excluding the above, it may exhibit auto shut-down symptoms, which is designed to protect your projector from overheating. In cases like this, you should switch to High Altitude Mode to solve these symptoms. However, this is not to state that this projector can operate under any and all harsh or extreme conditions.

## Adjusting the sound

The sound adjustment functions displayed below will have an effect on the projector speaker(s). Be sure you have made a correct connection to the projector audio input. See "[Connecting a computer](#)" on page 17 for details on audio input connection when a separate audio input cable is used to connect the projector.

### Adjusting the sound mode

This project is preset with four sound modes to enrich your listening experience. You can choose one of the four preset sound modes: **Standard**, **Cinema**, **Music**, and **Game** based on your needs.

1. Highlight **Settings** and press **OK** to enter.
2. Go to **Advanced > Audio Settings** and press **OK** to enter.
3. Highlight **Sound Mode** and press **OK** to open the pop-up menu.
4. Highlight desired mode and press **OK** to confirm.
5. To leave the OSD, press  $\rightarrow$  until the projector returns to the home screen, or press  $\uparrow$  to go back to the home screen directly.

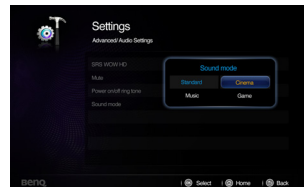

## SRS WOW HD™

Activating this function enables the SRS WOW HD™ technology. The projector can provide surround sound and restore natural sound.

1. Highlight **Settings** and press **OK** to enter.
2. Go to **Advanced > Audio Settings** and press **OK** to enter.
3. Highlight **SRS WOW HD™** and press **OK** to open the pop-up menu.
4. Highlight **On** and press **OK** to confirm.
5. To leave the OSD, press **↵** until the projector returns to the home screen, or press **⏠** to go back to the home screen directly.

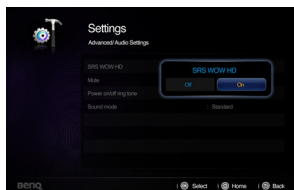

## Muting the sound

To temporarily turn off the sound, press **⏸** on the remote control, or:

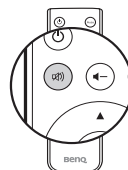

1. Highlight **Settings** and press **OK** to enter.
2. Go to **Advanced > Audio Settings** and press **OK** to enter.
3. Highlight **Mute** and press **OK** to open the pop-up menu.
4. Highlight **On** and press **OK** to confirm.
5. To leave the OSD, press **↵** until the projector returns to the home screen, or press **⏠** to go back to the home screen directly.

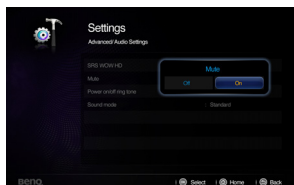

## Turning off Power on/off ring tone

To turn off the Power on/off ring tone:

1. Repeat steps 1-2 above.
2. Highlight **Power on/off ring tone** and press **OK** to open the pop-up menu.
3. Highlight **Off** and press **OK** to confirm.

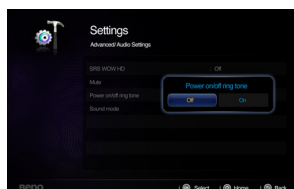

 The only way to change Power On/Off Ring Tone is setting On or Off here. Setting the sound mute or changing the sound level will not affect the Power On/Off Ring Tone.

# Displaying images with PC and video source devices

You can connect your projector to a PC and various video source devices. (e.g. HDMI, MHL, composite video, component video) However, you need only to connect the projector to one input source device.

To display images:

1. Connect the projector to one of the signal sources.
2. Turn on the power of the projector and your source device. The projector displays the home screen.
3. Press ◀/▶ on the projector or remote control to select the input signal and then press **OK** to enter.

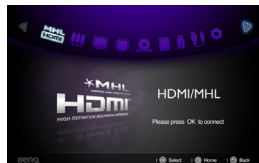

4. Press ⇨ or ⇩ to go back to home screen (Does not apply when using MHL as input source).

 **Certain remote control functions might not work under MHL operation because the MHL device being used may not support these functions. Please check your MHL device for available functions.**

# Using PC/ Video pop-up menus

The projector has a multilingual OSD that allows you to make image adjustments and change a variety of settings. This menu is for the settings to be used in computer, composite video, component and HDMI modes.

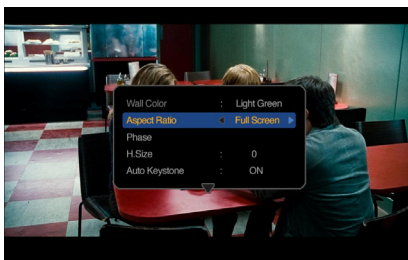

## Using the menu



1. To open the OSD menu, press **⏏** on the projector or remote control when the projection screen is displayed.
2. When the OSD is displayed, press **▲/▼** to select the desired item and adjust the settings by using **◀/▶**.
3. To leave the OSD, press **⏏** again.

## Menu system

Menu Item	Sub-menu	Options
<b>Wall Color</b>		Off/Light Yellow/Pink/Light Green/Blue/Blackboard
<b>Aspect Ratio</b>		Auto/Real/4:3/16:9/16:10
<b>Phase</b>		0-31
<b>H. Size</b>		-6~6
<b>Color Space Conversion</b>		Auto/RGB/YUV
<b>Auto Keystone</b>		On/Off
<b>Keystone</b>		
<b>Picture Mode Settings</b>	Picture Mode	Bright/Standard/Cinema/Game/User
	Reference Mode	Bright/Standard/Cinema/Game
	Brightness	
	Contrast	
	Color	
	Tint	
	Sharpness	
	Color Temperature	Normal/Cold/Warm
	3D Sync Invert	Disable/Invert
Save Settings		
<b>Information</b>		Source
		Resolution
		Color System



## Description of each menu

FUNCTION	DESCRIPTION
<b>Wall Color</b>	Corrects the projected picture's color when the projection surface is not white. See " <a href="#">Using Wall Color</a> " on page 34 for details.
<b>Aspect Ratio</b>	There are four options to set the image's aspect ratio depending on your input signal source. See " <a href="#">Selecting the aspect ratio</a> " on page 33 for details.
<b>Phase</b>	Adjusts the clock phase to reduce picture distortion.
<b>H. Size</b>	Adjusts the horizontal width of the picture.
<b>Color Space Conversion</b>	Corrects the color space under HDMI mode. See " <a href="#">Changing color space</a> " on page 28 for details
<b>Auto Keystone</b>	Auto corrects any keystone of the image.
<b>Keystone</b>	Corrects any keystone of the image. See " <a href="#">Correcting keystone</a> " on page 30 for details.
<b>Picture Mode Settings</b>	<p><b>Picture Mode</b> See "<a href="#">Selecting a picture mode</a>" on page 34 for details.</p> <p><b>Reference Mode</b> See "<a href="#">Setting the User mode</a>" on page 34 for details.</p> <p> This function is only available when User is selected.</p> <p><b>Brightness</b> See "<a href="#">Adjusting Brightness</a>" on page 35 for details.</p> <p><b>Contrast</b> See "<a href="#">Adjusting Contrast</a>" on page 35 for details.</p> <p><b>Color</b> See "<a href="#">Adjusting Color</a>" on page 35 for details.</p> <p><b>Tint</b> See "<a href="#">Adjusting Tint</a>" on page 35 for details.</p> <p> This function is only available the system format is NTSC.</p> <p><b>Sharpness</b> See "<a href="#">Adjusting Sharpness</a>" on page 35 for details.</p> <p><b>Color Temperature</b> See "<a href="#">Selecting a Color Temperature</a>" on page 35 for details.</p> <p><b>3D Sync Invert</b> When you discover the inversion of the image depth, enable this function to correct the problem.</p> <p><b>Save Settings</b> Saves the settings made for User mode.</p>

<b>Information</b>	<b>Source</b> Shows the current signal source. <b>Resolution</b> Shows the native resolution of the input signal. <b>Color System</b> Shows input system format, NTSC, PAL, SECAM, or RGB.
--------------------	---

# Displaying files with internal memory, USB drive and SD card

The projector can display files saved in internal memory or external storage like an SD card or a USB drive when you connect it to the projector.

## To display files:

1. Turn on the power of the projector and the projector displays the home screen.
2. Connect the projector to one of the above external memory devices.
3. Press ◀/▶ to select SD card, USB Drive/Wireless Display or internal memory.

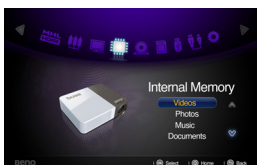
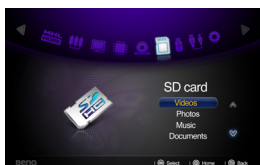

4. Storages are classified into **Videos, Photos, Music, Documents** menu in home screen. Press ▲/▼ to select desired item and then press **OK** to enter different file browser.

☞ See "Using wireless streaming" on page 57 for details about the wireless display.

## File browser window

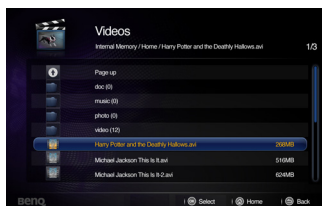

Videos

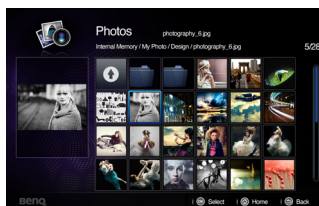

Photos

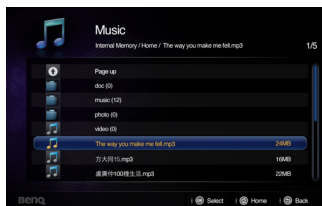

Music

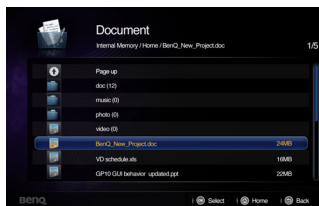

Documents

☞ You will only see relevant and supported files in each of file browser.

## When playing videos

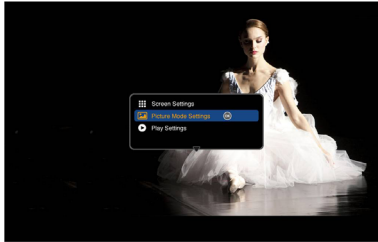

NAME		DESCRIPTION
OK/ ▶	Play/Pause	Plays or pauses video.
⏸	Pause	Pauses video.
▲ / ▼	Volume+/-	Adjusts volume up/down.
◀◀	Rewind	Press to rewind the video.
▶▶	Fast-forward	Press to fast-forward the video.
⏮	Prev.	Plays the previous video.
⏭	Next	Plays the next video
◀	Prev.	<ul style="list-style-type: none"> <li>Plays the previous video.</li> <li>Press and hold to rewind the video.</li> </ul>
▶	Next	<ul style="list-style-type: none"> <li>Plays the next video.</li> <li>Press and hold to fast-forward the video.</li> </ul>
⋮	Menu	Opens/closes video pop-up settings menu.
↶	Back	<ul style="list-style-type: none"> <li>Returns to upper level of OSD.</li> <li>Closes video pop-up setting menu.</li> <li>Leaves current video player and back to video file browser.</li> </ul>
🏠	Home	Exits video player and go back to home screen.

### Video player pop-up settings menu

The video player pop-up menu provides an on-screen display (OSD) for adjustments when playing videos.

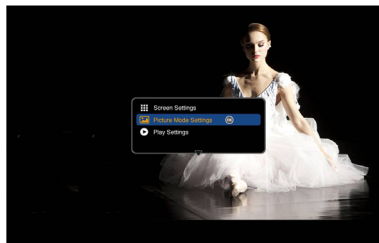

### Using the menu

- To open the OSD menu, press **⋮** on the projector or remote control when the projection screen is displayed.

2. When the OSD is displayed, press ▲/▼ to select the desired item and adjust the settings by using ◀/▶.
3. To exit the OSD, press ⏏ on the projector or remote control again.

 • See the table for supported subtitle file types. Refer to "[Supported file formats](#)" on page 54.

## Menu system

Menu Item	Sub-menu	Options
<b>Screen Settings</b>	Wall Color	Off/Light Yellow/Pink/Light Green/Blue/Blackboard
	Auto Keystone	On/Off
	Keystone	
<b>Picture Mode Settings</b>	Picture Mode	Bright/Standard/Cinema/Game/User
	Reference Mode	Bright/Standard/Cinema/Game
	Brightness	
	Contrast	
	Color Temperature	Warm/Normal/Cool
	Save Settings	
<b>Play Settings</b>	Play Mode	All in folder/One video
	Play Order	Normal/Shuffle
	Repeat	On/Off

## Description of each menu

FUNCTION	DESCRIPTION
<p><b>Screen Settings</b></p>	<p><b>Wall Color</b> Corrects the projected picture's color when the projection surface is not white. See "<a href="#">Using Wall Color</a>" on page 34 for details.</p> <p><b>Auto Keystone</b> Auto corrects any keystone of the image.</p> <p><b>Keystone</b> Corrects any keystone of the image. See "<a href="#">Correcting keystone</a>" on page 30 for details.</p>
<p><b>Picture Mode Settings</b></p>	<p><b>Picture Mode</b> Pre-defined picture modes are provided so you can optimize your projector image set-up to suit your program type.</p> <p><b>Reference Mode</b> Selects a picture mode that best suits your need for the image quality and further fine-tune the image based on the selections listed on the same page below.</p> <p> <b>This function is only available when User mode is selected.</b></p> <p><b>Brightness</b> Adjusts the brightness of the image.</p> <p><b>Contrast</b> Adjusts the degree of difference between dark and light in the image.</p> <p><b>Color Temperature</b> Adjusts the color temperature. <b>Cool</b> makes images appear bluish white. <b>Normal</b> maintains normal colorings for white. <b>Warm</b> makes images appear reddish white.</p> <p><b>Save Settings</b> Saves the settings made for User mode.</p>
<p><b>Play Settings</b></p>	<p><b>Play Mode</b> Choose to play one video or all videos in a folder.</p> <p><b>Play Order</b> Select the playback order of video files.</p> <p><b>Repeat</b> Select whether to repeat video playback.</p>

## When playing music

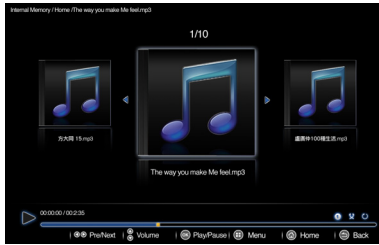

NAME		DESCRIPTION
OK/▶	Play/Pause	Plays or pauses music.
⏸	Pause	Pauses music.
⏮	Rewind	Rewinds the music.
⏭	Fast-forward	Fast-forwards the music.
⏪	Prev.	Plays the previous music.
⏩	Next	Plays the next music
▲/▼	Volume+/-	Adjusts volume up/down.
◀	Prev.	<ul style="list-style-type: none"> <li>Plays the previous music.</li> <li>Press and hold to rewind the music.</li> </ul>
▶	Next	<ul style="list-style-type: none"> <li>Plays the next music.</li> <li>Press and hold to fast-forward the music.</li> </ul>
⋮	Menu	Opens/closes music pop-up settings menu.
↶	Back	<ul style="list-style-type: none"> <li>Returns to upper level of OSD.</li> <li>Closes video pop-up setting menu.</li> <li>Leaves current music player and back to music file browser.</li> </ul>
🏠	Home	Exits music player and go back to home screen.

## Music player pop-up settings menu

The music player pop-up menu provides an on-screen display (OSD) for adjustments when playing music.

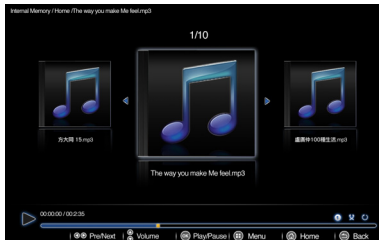

## Using the menu

1. To open the OSD menu, press **⏏** on the projector or remote control when the projection screen is displayed.
2. When the OSD is displayed, press **▲/▼** to select the desired item and adjust the settings by using **◀/▶**.
3. To exit the OSD, press **⏏** on the projector or remote control again.

## Menu system

Menu Item	Options
Play Mode	All in folder/One music
Play Order	Normal / Shuffle
Repeat	On/Off

## Description of each menu

FUNCTION	DESCRIPTION
Play Mode	Choose to play one music or all music in a folder.
Play Order	Select the playback order of music files.
Repeat	Select whether to repeat music playback.



## When viewing photos

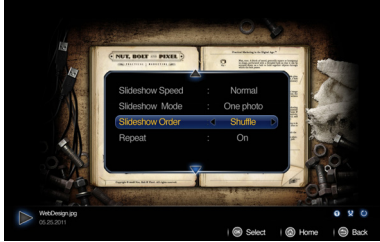

NAME		DESCRIPTION
OK/Blank / ▶	Play/Pause	Plays or pauses slideshow.
◀ / ⏪	Prev	Plays previous photo.
▶ / ⏩	Next	Plays next photo.
⋮	Menu	Opens/closes photo pop-up settings menu.
↶	Back	<ul style="list-style-type: none"> <li>• Returns to upper level of OSD.</li> <li>• Closes photo pop-up setting menu.</li> <li>• Leaves current photo player and back to photo file browser.</li> </ul>
⏴	Home	Exits photo player and go back to home screen.

### Photo viewer pop-up settings menu

The photo view pop-up menu provides an on-screen display (OSD) for adjustments when viewing photos.

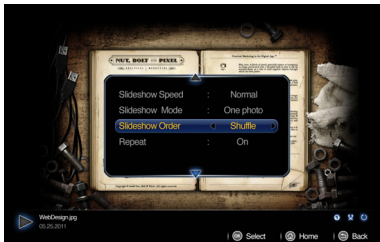

### Using the menu

1. To open the OSD menu, press **⋮** on the projector or remote control when the projection screen is displayed.
2. When the OSD is displayed, press **▲/▼** to select the desired item and adjust the settings by using **◀/▶**.
3. To exit the OSD, press **⋮** on the projector or remote control again.

## Menu system

Menu Item	Sub-menu	Options
<b>Screen Settings</b>	Wall Color	Off/Light Yellow/Pink/Light Green/Blue/Blackboard
	Auto Keystone	On/Off
	Keystone	
<b>Picture Mode Settings</b>	Picture Mode	Bright/Standard/Cinema/Game/User
	Reference Mode	Bright/Standard/Cinema/Game
	Brightness	
	Contrast	
	Color Temperature	Warm/Normal/Cool
	Save Settings	
<b>Play Settings</b>	Slideshow Speed	Fast/ Normal/ Slow
	Slideshow Mode	All in folder / One photo
	Slideshow Order	Normal / Shuffle
	Repeat	On/Off

## Description of each menu

FUNCTION	DESCRIPTION
<b>Screen Settings</b>	<b>Wall Color</b> Corrects the projected picture's color when the projection surface is not white. See " <a href="#">Using Wall Color</a> " on page 34 for details.
	<b>Auto Keystone</b> Auto corrects any keystone of the image.
	<b>Keystone</b> Corrects any keystone of the image. See " <a href="#">Correcting keystone</a> " on page 30 for details.

<p><b>Picture Mode Settings</b></p>	<p><b>Picture Mode</b> Pre-defined picture modes are provided so you can optimize your projector image set-up to suit your program type.</p> <p><b>Reference Mode</b> Selects a picture mode that best suits your need for the image quality and further fine-tune the image based on the selections listed on the same page below.</p> <p> <b>This function is only available when User mode is selected.</b></p> <p><b>Brightness</b> Adjusts the brightness of the image.</p> <p><b>Contrast</b> Adjusts the degree of difference between dark and light in the image.</p> <p><b>Color Temperature</b> Adjusts the color temperature. <b>Cool</b> makes images appear bluish white. <b>Normal</b> maintains normal colorings for white. <b>Warm</b> makes images appear reddish white.</p> <p><b>Save Settings</b> Saves the settings made for User mode.</p>
<p><b>Slideshow Speed</b></p>	<p>Lets you select slideshow speed.</p>
<p><b>Slideshow Mode</b></p>	<p>Lets you choose to slideshow one photo or all photos in a folder.</p>
<p><b>Slideshow Order</b></p>	<p>Lets you select the slideshow order of photo files.</p>
<p><b>Repeat</b></p>	<p>Lets you select whether to repeat slideshow.</p>

## When viewing documents



NAME		DESCRIPTION
OK	Enter	Enlarges the current page. Magnify the page with a further press.
▲ / (⏪)	Up	1. When the page is not enlarged: ▲ / (⏪): Moves to the previous page. ▼ / (⏩): Moves to the next page. 2. When the page is enlarged: ▲ / ▼ / ◀ / ▶: Moves to the top/down/left/right portion of the page.
▼ / (⏩)	Down	
◀	Left	
▶	Right	
⋮	Menu	Brings out the pop-up menu.
↶	Back	Leaves current document viewer and back to document file browser.
🏠	Home	Exits document viewer and back to home screen.

- ☞ • Loading time may be longer for large files.
- Document viewer may not work properly when a file does not comply with standards or if it is damaged.
- Document viewer may not work when a file contains too much data to display on a screen. (For example, too much data on one sheet in an Excel file.)
- Document viewer supports only one font. If a screen uses other fonts, the image displayed by Media Play may be different from the original screen.
- For example:
  1. The position of line breaks in a sentence might be dissimilar.
  2. The position of page breaks in a MS Word document might be changed. In this case, the document might be shown incompletely according to the Layout properties for **Picture** or **Shapes** or **Object** in MS word. (Please refer to the manual of MS Word for more information on the Layout properties.)
- Some functions supported on your PC are not supported by this projector, like these PowerPoint functions: Animation, 3D, Smart Art, Hyper Link, and Transparency and Gradation.
- This projector does not support encrypted files (DRM).

## Document viewer pop-up settings menu

The document view pop-up menu provides an on-screen display (OSD) for adjustments when viewing photos.



### Using the menu

1. To open the OSD menu, press **⏏** on the projector or remote control when the projection screen is displayed.
2. When the OSD is displayed, press **▲/▼** to select the desired item and adjust the settings by using **◀/▶**.
3. To exit the OSD, press **⏏** on the projector or remote control again.

### Menu system

Menu Item	Options
Page Navigation	
Aspect Ratio	Fit to Width / Fit to Height

### Description of each menu

FUNCTION	DESCRIPTION
Page Navigation	Goes directly to a specific page. Enter a page number using the <b>▲/▼/◀/▶</b> buttons, check the page number in the preview window on the upper right corner of the screen, and then select <b>&lt;Go&gt;</b> to move to that page.
Aspect Ratio	<b>Fit to Width</b> displays a document so that it fits the screen width. <b>Fit to Height</b> displays a document so that it fits the screen height.

## Supported file formats

- Document, Photo, Music

ITEM	FILE EXTENSION
Document	Adobe PDF 1.0~1.4 (PDF)
	MS PowerPoint 97~2010 (ppt, pptx)
	MS Excel 95~2010, Office XP (xls,xlsx)
	MS Word 95~2010, Office XP (doc, docx)
Photo	JPG (.jpg, .jpeg), BMP (.bmp)
Music	MP3, MP2, MP1, OGG, AAC, WAV

- Video, Subtitles

ITEM	FILE EXTENSION	DESCRIPTION
Video	AVI (Xvid, MJPEG), DVIX (MJPEG, XVID), DAT (MPEG I), MPG(MPEG I), MPEG(MPEG I)	
Subtitles	SRT (.srt)	<ul style="list-style-type: none"> <li>• Subtitle files must be in the same directory as the video files.</li> <li>• The name of subtitle files shall be the same as the name of video files.</li> <li>• SRT only supports for UTF (unicode 8).</li> </ul>
<b>Bit rate range: If peak bit rate of a video file is larger than 10MB, it might cause video playback lag.</b>		

 Please visit [BenQ.com](http://BenQ.com) to learn more details about the latest supported formats.

# Using USB streaming

The projector supports USB streaming for USB display and USB file transfer.

## BenQ USB EZ display

The projector can project computer screen via a USB cable instead of a VGA cable.

To use USB display:

1. Connect the projector to a computer using a USB cable.
2. Turn on the power of the projector and your source device. The projector displays the home screen.
3. Press ◀/▶ to select USB Streaming.
4. Press ▲/▼ to select USB Display and then press **OK** to enter.
5. If your computer can automatically install USB driver, the projector will project your computer's screen.
6. If your computer screen cannot be projected, please go to "My Computer", find the "BenQ USB EZ Display" (same as using a flash disk drive), and run the "Autorun.exe" file.
7. Press ⇨ or ⇩ to leave computer projection screen and back to projector home screen.



## System requirements

Windows	CPU	Intel/AMD Dual Core 2 GHz or higher (ATOM not supported)
	Graphic card	Intel, nVIDIA or AMD graphic card with 64MB VRAM or above
	OS	Windows XP Professional SP3, Vista SP3, Windows 7 SP2
	DRAM	1 GB DDR

## USB file transfer

You can connect the projector to transfer files from your computer to the projector. The files will be saved in the internal memory, and you can project images from the projector.

To use USB file transfer:

1. Connect the projector to a computer using a USB cable.
2. Turn on the power of the projector and your source device. The projector displays the home screen.
3. Press ◀/▶ to select USB Streaming.
4. Press ▲/▼ to select USB File Transfer and then press **OK** to enter.
5. If the connection is successful, you will see "It is in USB file transfer mode." message on the screen.
6. Look for a new "removable disk" icon. This "removable disk" is actually the internal memory in your projector.
7. Copy & Paste or Drag-N-Drop files from your computer to the removable disk.
8. If you want to display those files, use ◀/▶ to select Internal Memory. See ["Displaying files with internal memory, USB drive and SD card" on page 43](#) for details.
9. Press ↵ or ⏪ to leave USB File Transfer mode and back to projector home screen.



To disconnect the projector from a PC:



Make sure to end the connection properly to prevent damage to the projector or your data.

1. Click on the Windows Taskbar.
2. Click the pop-up message.
3. Disconnect the USB cable only when the message says that it is safe to remove the hardware.

- ☞ **Do not disconnect the USB cable while files are being copied, as this could result in loss of data or damage to the projector.**
- **The connection will not end if you have projector files open on the PC. Close all projector files and try again.**
- **Other versions of Windows operate similarly. Follow the correct procedure for removing a USB device from your PC safely for your version of Windows.**



# Using wireless streaming

The wireless dongle included in this package provides you with two modes to project images wirelessly. One is by using “**PC Display**” while the other is by using “**Mobile Display**”.

## Display PC screen to projector wirelessly (PC Display)

BenQ EZ QPresenter 2.0 for PC is a powerful program that allows you to project your computer screen with this projector via wireless connection. It also brings you extension display function so that you can show different contents in the secondary display.

If you are using PC Display function for the first time, you need to download “**BenQ EZ QPresenter 2.0**” application from GP20 and install it on your computer prior to using this function. Follow the steps below to get your projector set up in just a few minutes.

1. Connect the wireless dongle to the USB jack of the projector.

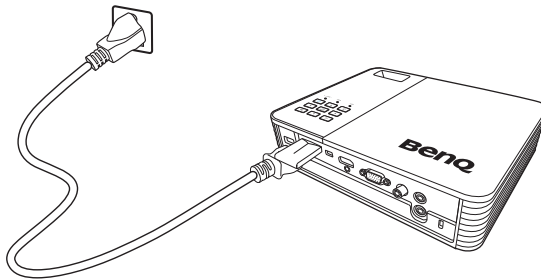

2. Go to **Settings > Network > Wi-Fi Mode** to check your network settings.
  - i. GP20 Wi-Fi mode is set to **AP Mode** as the default mode. Open your computer's wireless network and search for “**BenQ GP20**” (Device Name SSID) in wireless access point menu and connect to it.
  - ii. If GP20 Wi-Fi mode is set to **Client Mode**, you should connect both your computer and GP20 to the same Wi-Fi network.  
(See "[Setting up Wi-Fi Network](#)" on page 68 for details on Wi-Fi connection)
3. Select “**USB Drive/Wireless Streaming**” by pressing ◀ / ▶ and press “**OK**” on your projector or remote control. Choose “**PC Display**”.



4. You will be prompted to the “PC Display welcome page”



(AP Mode)



(Client Mode)

5. Follow the steps of “To install BenQ EZ QPresenter 2.0” in PC Display Welcome Page.

- i. When GP20 is in **AP Mode**, start a web browser, key in IP address **192.168.100.10** into the address bar and press **Enter**. When GP20 is in **Client Mode**, start a web browser and key in assigned IP address shown in the PC Display Welcome Page. You will be prompted to “**BenQ EZ QPresenter 2.0 download page**”.

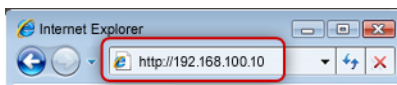

- ii. Select OS version and start downloading and installing BenQ EZ QPresenter 2.0 by following the on-screen instructions on your PC. After installation is

complete, the BenQ EZ QPresenter 2.0 icon will be displayed on your computer desktop.

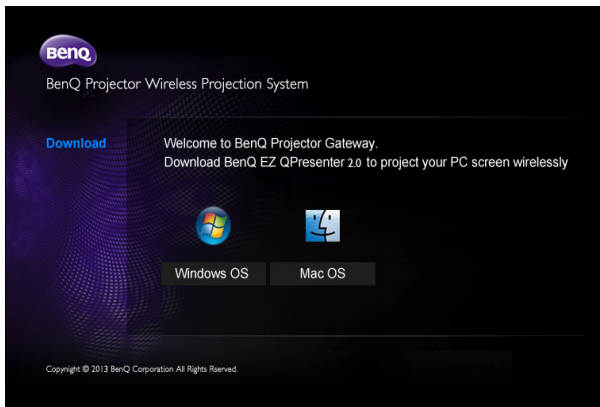

6. Double click the QPresenter icon on your computer desktop to open the app.
  - i. When GP20 is in **AP Mode**, click on the “Search” icon of EZ QPresenter 2.0 and choose “**BenQ GP20**” from the network list; press “Connect” to start projection.
  - ii. When GP20 is in **Client Mode**, please connect GP20 to your local Wi-Fi network first. Then, click on the “Search” icon of EZ QPresenter 2.0; from the network list menu, choose the local network which GP20 is connected to and press “Connect” to start projection. You may also type in the IP address directly and press “Connect” to start projection.

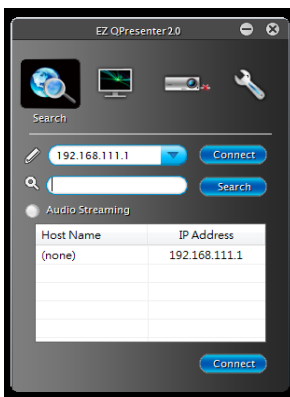

 You can disable or enable audio streaming based on your preferences.

7. The Feature page allows you to manage the display image on your projector.

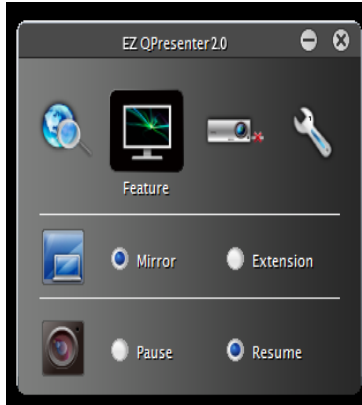

- i. You can choose mirror or extension to display PC screen in different ways.
  - ii. You can select Pause / Resume to stop or restart projection of the PC screen.
8. The Settings pages allows you to configure the QPresenter.

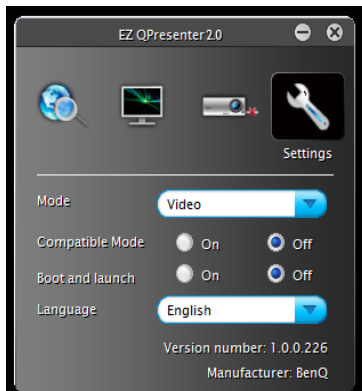

- i. You can select Video or Graphic display mode. Graphic Mode: inferior image quality but faster transmission speed. Video Mode: superior image quality but slower transmission speed. However, actual transmission performance shall depend upon the status of network during use.
- ii. Some applications use Windows graphics so that their OSD may not be drawn correctly. You can enable **Compatible Mode** to resolve this problem.
- iii. You can select whether to automatically open the EZ QPresenter 2.0 application when the computer is powered on.
- iv. When you install the EZ QPresenter 2.0, the program will automatically identify the language of your computer's operating system and install the same language as your operating system. If your language is not included, the system will use English as the default setting.

 Resolution change during Wi-Fi display is prohibited.

## Frequently Asked Questions

- **Q: Why does my CPU become busier after launching the BenQ EZ QPresenter 2.0?**
- A: BenQ EZ QPresenter 2.0 counts on your PC CPU to encode the screen images to reduce the data that needs to be transferred to the receiver. Hence there will be some overhead to your PC. In general, for 4+ ranking PCs, it would need up to 30% of CPU overhead to perform wireless display.
- **Q: Why can't I project my screen?**
- A: BenQ EZ QPresenter 2.0 needs to access the network connection at some point. As a result, when your Anti-virus or network security software prompts you for permission to allow the sender software to access the network, please grant access to proceed, or choose "add rule" to the fire wall settings.
- **Q: Why does my display frame rate slow down?**
- A: BenQ EZ QPresenter 2.0 needs to encode display content while sending massive real-time data to the projector.
  - i. PC: A dual core PC (excluding Atom processors) or Mac is required to encode the screen images at 30FPS (Frame Per Second) speed. However, if you would like to increase the FPS speed, you can:
    - a. Use better media players, such as GOM player
    - b. Close all unused apps
    - c. Use a faster PC with Windows Experience Score higher than 4 (4+ recommended)
  - ii. Network: Using 802.11n Wi-Fi
    - a. Move your laptop closer to the projector
    - b. Disable the "Minimum Power Consumption" option from the "Advanced Tab" in your Wi-Fi network Adapter Property setting
    - c. Lower PC screen resolution

## System Requirements for PC Wireless Display

<b>Windows</b>	CPU	Dual core Intel Core I.6 GHz or higher (ATOM not supported)
	Graphic card	Intel, NVIDIA or AMD graphic card with 64MB VRAM or above
	OS	Windows XP SP3, Vista SP2, Windows 7 SP1 and Win8 (Do not support Starter version)
	HDD	40MB free space
	Display mode	Mirror Display Extension Display (Do not support Win8) Audio on / off (Audio streaming is not supported by WinXP)
	Wi-Fi	802.11n

<b>Mac</b>	CPU	Intel Dual core 1.4 GHz or higher (PowerPC not supported)
	Graphic card	Intel, NVIDIA or AMD graphic card with 64MB VRAM or above
	OS	Mac OS X 10.7 and above
	Display mode	Mirror Display Extension Display
	Recommended Models	MacBook series and iMac series released after the end of 2011
	Wi-Fi	802.11n

## Display mobile device content to projector wirelessly (Mobile Display)

The **“BenQ EZ QPresenter 2.0”** for Mobile is an easy-to-use app which enables your mobile devices to project the display with BenQ GP20 Ultra Lite LED projector. You can display your photos and documents, including files with PDF, MS-Office and iWorks formats. Furthermore, you can also project web browser contents from your mobile device using this projector.

If you are using Mobile Display function for the first time, you need to download **“BenQ EZ QPresenter 2.0”** app from App Store or Google Play and install it on your computer before you can use this function. Follow the steps below to get your projector set up in just a few minutes.

1. Connect the wireless dongle to the USB jack of the projector.

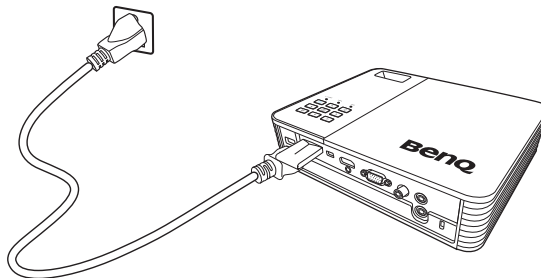

2. Select **“USB Drive/Wireless Streaming”** by pressing ◀ / ▶ and press **“OK”** on your projector. Choose **“Mobile Display”**.



3. You will be prompted to the **“Mobile Display welcome page”**



(AP Mode)



(Client Mode)

4. Follow the steps of **“To project using BenQ EZ QPresenter 2.0”** in Mobile Display Welcome Page.
- Download “BenQ EZ QPresenter 2.0” from App Store or Google Play and install it on your mobile device.
  - When GP20 is set to AP Mode, select “BenQ GP20” from wireless access point menu of your mobile device and open “BenQ EZ QPresenter 2.0” to start projection.
  - When GP20 is set to Client Mode, connect GP20 and your mobile device to the same Wi-Fi network. Open “BenQ EZ QPresenter 2.0” to start projection. (See ["Setting up Wi-Fi Network" on page 68](#) for details on Wi-Fi connection)

### Features of EZ QPresenter 2.0:

- View MS-Office files (Word, Excel, PowerPoint), Adobe PDF, Apple iWorks (Pages, Numbers, Keynote), and local photo gallery. It also supports Sketch function and saves to photo roll.
  - “Files” page allows you to project Documents, Photos, and supports Dropbox on your mobile device.



- Documents feature **“Edit”**, **“Jump”**, and **“Sketch”** functions.



- i. **“Edit”** function allows you to delete documents on your mobile device.
- ii. **“Jump to page”** allows you to select and go to the desired page directly.
- iii. **“Sketch”** function allows you to display documents in full screen. The sketch tool bar at the bottom of the screen allows you to edit the projection screen while the image is being projected.



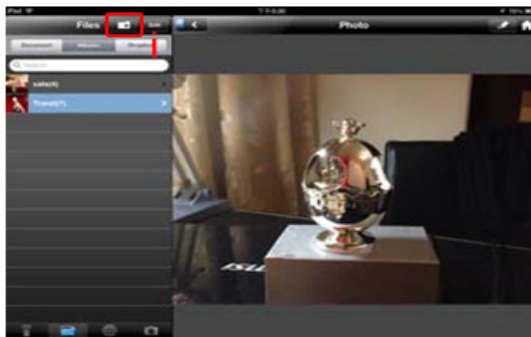

 The Sketch function is also supported under Web and Cam modes.

- **“Photos”** page allows you to project photos that are saved in the camera roll on your mobile device. You may add a photo or create an album folder under this function.

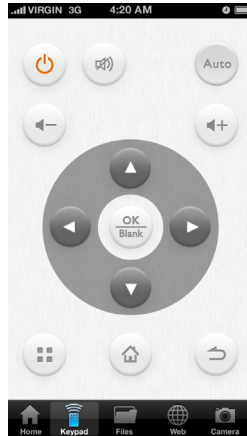

2. Control the projector remotely with your mobile device through Wi-Fi network.
  - **“Keypad”** page displays GP20 RC keypad and allows you to control the projector from your mobile device through Wi-Fi network.



 This feature is only applicable when **GP20** and the mobile device are both under the same network in **Wi-Fi** client mode.

3. Display web pages
  - **“Web”** function allows you to display any web page shown on your mobile device.
  - **“Sketch”** function is supported under the “Web” function.



 This feature is only applicable when **GP20** and the mobile device are both under the same network in **Wi-Fi** client mode.

4. Stream image data from camera.

“Cam” function allows you to take photos and save them in camera roll.



5. Display Dropbox files

Dropbox allows you to bring your files anywhere and share them with ease. Access any file you saved in your Dropbox from you computer, iPhone, iPod, or the Dropbox website.



 This feature is only applicable when GP20 and the mobile device are both under the same network in Wi-Fi client mode.

### Supported device:

- i. iPhone 4 and iPhone 4S, iPhone 5
- ii. iPad 2, and New iPad (gen. 3 iPad)

# Setting up Wi-Fi Network

The Network function of this projector enables wireless connection between this projector and your source device using a Wi-Fi dongle, allowing you to project files from your source device wirelessly. Setup your projector network in few simple steps to enable your projector's wireless network function.

## Connecting to a network using AP Mode

1. Go to **Settings**> **Network**> **Wi-Fi Mode**, press **OK** and a pop-up menu appears. Select **AP Mode** and press **OK**.

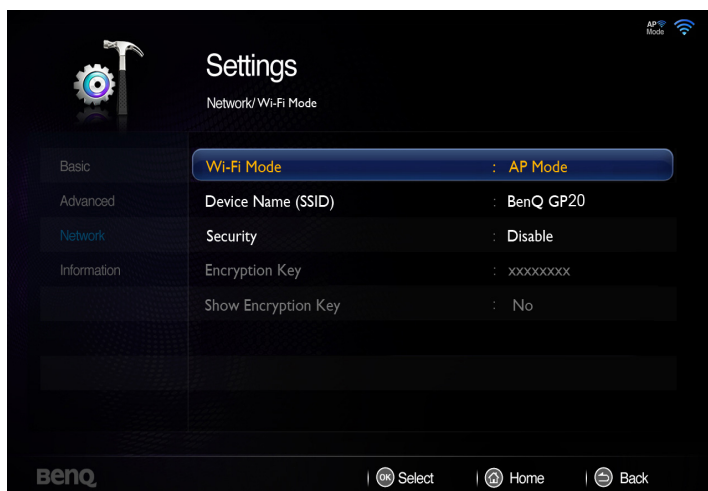

2. Press **▼** to select **Device Name (SSID)** and press **OK**. Using the pop-up keypad, input your desired name, choose **Connect** and press **OK**.
3. Follow OSD directions and set encryption code. (Only if **Security** is enabled)
4. Press **↵** or **⏪** to leave **Network** and back to projector home screen.

## Connecting to a network using Client Mode

1. Go to **Settings**> **Network**> **Wi-Fi Mode**, press **OK** and a pop-up menu appears. Select **Client Mode** and press **OK**.
2. Press **▼** to select **Wi-Fi Connection** and press **OK**. The screen will display the AP name it is connected to. If no connection is found, a pop-up menu will appear.
3. From the pop-up menu, select the desired AP and press **OK**.

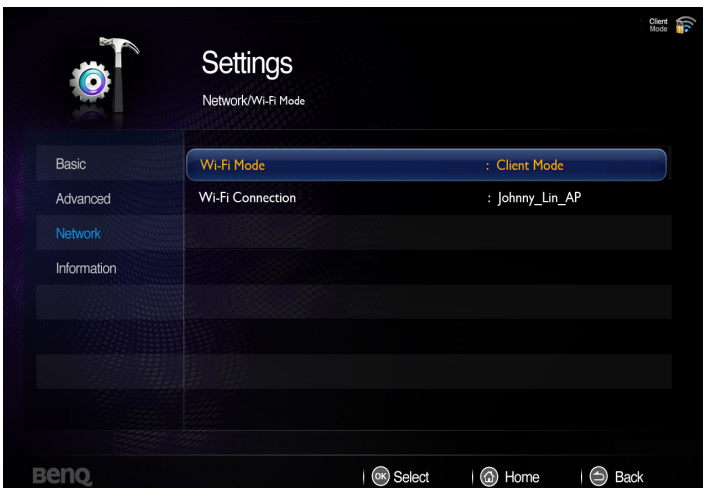

4. Follow OSD directions and set encryption code. (Only if **Security** is enabled)
5. Press **→** or **↶** to leave **Network** and back to projector home screen.

## Wi-Fi Dongle Specifications

Model Name	WDRT8192
Wireless Standard	IEEE 802.11 b/g/n
Interface	USB 2.0
Data Transfer Rate	up to 300Mbps
Frequency Band	2.4GHz ISM Band
Security	64 bit/128 bit WEP, TKIP, AES, WPA, WPA2
Supported OS	Windows 2000/XP/Vista/7
Minimum PC System Requirement	CPU: 200MHz or above RAM: 64MB RAM or above, 128MB recommended

# Using settings menu

This menu is to set the projector's operating environment.

Using the menu

1. To open the OSD menu, press ◀/▶ to select **Settings** icon in home screen.
2. When the OSD is displayed, press ▲/▼ to select any item in the main menu.
3. After selecting the desired main menu item, press **OK** to enter the feature settings sub-menu.
4. Press ▲/▼ to select the desired item and press **OK** to open the pop-up menu.
5. Select the settings using ▲/▼/◀/▶ and press **OK** to confirm. Once the setting is selected, the OSD menu returns to the selected item.
6. Press ↵ to return to the main menu.  
You may press ⏪ to go back to home screen directly.
7. Press ↵ again to go back to home screen.

## Menu system

Main menu	Sub-menu	Options	
	Language	English / Français / Deutsch Italiano / Español / Русский 繁體中文 / 简体中文 / 日本語 / 한국어 / Svenska / Nederlands / Türkçe / Čeština / Português / ไทย / Polski Magyar / Български / Hrvatski / Română / Suomi / Norsk / Dansk / Indonesian / Ελληνικά / العربية / हिन्दी	
<b>1. Basic</b>	LED Mode	Normal/Eco	
	Wall Color	Off/Light Yellow/Pink/Light Green/Blue/Blackboard	
	Auto Keystone	On/Off	
	Eye Protection	On/Off	
	Auto Power Off	Disable/5 min/10 min/15 min/20 min/25 min/30 min	
	Quick Auto Search	On/Off	
	Splash Screen	BenQ/ Black/Blue	
	Test Pattern	On/Off	
	High Altitude Mode	On/Off	
	<b>2. Advanced</b>	SRS WOW HD™	On/Off
Audio Settings		Sound Mode Standard/Cinema/Music/Game	
Mute		Off/On	
Volume			
Power on/off ring tone		On/Off	
Menu Display Time		5 sec/10 sec/15 sec/20 sec/25 sec/30 sec	
Security Settings		Change Password	
		Recall Password	
		Change Security Settings	
Power On Lock		On/Off	
Projector Position	Front Table/ Front Ceiling/ Rear Table/ Rear Ceiling		
Closed Caption	Closed Caption	On/Off	
	Enable		
Caption Version	CC1/CC2/CC3/CC4		
Firmware Upgrade	Yes/No		
Reset All Settings	Reset/Cancel		
<b>3. Network</b>	Wi-Fi Mode	AP Mode	
	Device Name (SSID)		
	Security	Disable/WPA/WPA2	
	Encryption Key	Gray out/ xxxxxxxxx	
	Show Encryption Key	Gray out/No/Yes	
	Wi-Fi Mode	Client Mode	
	Wi-Fi Connection	XXX_AP/ No connection	



---

**4.  
Information**

---

Source  
Picture Mode  
Color System  
Resolution  
DLP 3D  
LED Lamp Life  
Memory / Internal Memory  
Firmware Version

---

## Description of each menu

FUNCTION	DESCRIPTION	
<b>Language</b>	Sets the language for the On-Screen Display (OSD) menus.	
<b>LED Mode</b>	Choose <b>Eco</b> to dim the projector LED which will lower power consumption, extend the LED life and reduce noise. Choose <b>Normal</b> to return to normal mode.	
<b>Wall Color</b>	Corrects the projected picture's color when the projection surface is not white.	
<b>Auto Keystone</b>	Auto corrects any keystone of the image.	
<b>I. Basic menu</b>	<b>Eye Protection</b>	When detecting something is in front of the projection lens, the projector automatically hides the image. The effective range is 20 cm- 30 cm (varies with different ambient light and colors of reflected objects). See " <a href="#">Hiding the image</a> " on page 30 for details on how to restore the image.
	<b>Auto Power Off</b>	Allows the projector to turn off automatically if no input signal is detected after a set period of time.
	<b>Quick Auto Search</b>	Sets the projector to automatically search for input sources. If the source scan is On, the projector will scan for input sources until it acquires a signal. If a new signal source is detected under the home screen, the projector will automatically connect to the source and project image. If the new signal source is from SD card or USB drive, a sub-menu will automatically open.
	<b>Splash Screen</b>	Allows you to select which logo screen to display during projector start-up. Three options are available: BenQ logo, Black screen, or Blue screen.
	<b>Test Pattern</b>	Selecting <b>OK</b> enables the function and the projector displays the grid test pattern. It helps you adjust the image size and focus and check that the projected image is free from distortion.

FUNCTION	DESCRIPTION
<b>High Altitude Mode</b>	A mode for operation in high altitude areas. See " <a href="#">Operating in a high altitude environment</a> " on page 36 for details.
<b>Audio Settings</b>	See " <a href="#">Adjusting the sound</a> " on page 36 for details.
<b>Menu Display Time</b>	Sets the length of time the OSD will remain active after your last key press. The range is from 5 to 30 seconds in 5-second increments.
<b>Security Settings</b>	See " <a href="#">Securing the projector</a> " on page 31 for details.
<b>Projector Position</b>	Determines the position of the projector in respect to the screen in order to project the correct image.
<b>Closed Caption</b>	<p><b>Closed Caption Enable</b></p> <p>Activates the function by selecting <b>On</b> when the selected input signal carries closed captions.</p> <ul style="list-style-type: none"> <li>• Captions: An on-screen display of the dialogue, narration, and sound effects of TV programs and videos that are closed captioned (usually marked as "CC" in TV listings).</li> </ul>
	<p><b>Caption Version</b></p> <p>Selects a preferred closed captioning mode. To view captions, select CC1, CC2, CC3, or CC4 (CC1 displays captions in the primary language in your area).</p>
<b>Firmware Upgrade</b>	Updating the latest firmware are only allowed via an SD card.
<b>Reset All Settings</b>	Returns all settings to the factory preset values.

2. Advanced menu

<b>FUNCTION</b>		<b>DESCRIPTION</b>
<b>3. Information menu</b>	<b>Source</b>	Shows the current signal source.
	<b>Picture Mode</b>	Shows the selected mode.
	<b>Color System</b>	Shows input system format: RGB or YUV.
	<b>Resolution</b>	Shows the native resolution of the input signal.
	<b>DLP 3D</b>	Shows the DLP 3D status.
	<b>LED Lamp Life</b>	Displays the number of hours the lamp has been used.
	<b>Memory / Internal Memory</b>	Shows the memory capacity status: Internal Memory.
	<b>Firmware Version</b>	Shows firmware version.

# Shutting down the projector

1. Press **Power** and a confirmation message appears and prompts you to confirm shutdown.

If you don't respond in a few seconds, the message will disappear.

2. Press **Power** a second time.
3. The Power LED indicator flashes orange slowly and fans stop.
4. Disconnect the power cord from the power outlet if the projector will not be used for an extended period of time.

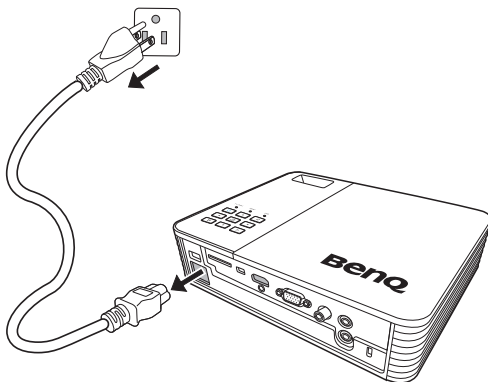
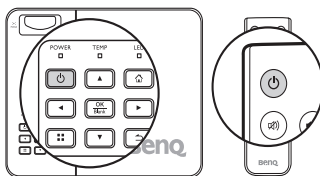

# Maintenance

## Care of the projector

Your projector needs little maintenance. The only thing you need to do on a regular basis is to keep the lens clean.

Never remove any parts of the projector. Contact your dealer if other parts need replacing.

### Cleaning the lens

Clean the lens whenever you notice dirt or dust on the surface.

- Use a canister of compressed air to remove dust.
- If there is dirt or smears, use lens-cleaning paper or moisten a soft cloth with lens cleaner and gently wipe the lens surface.

 **Never rub the lens with abrasive materials.**

### Cleaning the projector case

Before you clean the case, turn the projector off using proper shutdown procedure as described in "[Shutting down the projector](#)" on page 77 and unplug the power cord.

- To remove dirt or dust, wipe the case with a soft, lint-free cloth.
- To remove stubborn dirt or stains, moisten a soft cloth with water and a neutral pH detergent. Then wipe the case.

 **Never use wax, alcohol, benzene, thinner or other chemical detergents. These can damage the case.**

### Storing the projector

If you need to store the projector for an extended period of time, please follow the instructions below:

- Make sure the temperature and humidity of the storage area are within the recommended range for the projector. Please refer to "[Specifications](#)" on page 81 or consult your dealer about the range.
- Retract adjuster feet.
- Remove battery from the remote control.
- Pack the projector in its original packing or equivalent.

### Transporting the projector

It is recommended that you ship the projector with its original packing or equivalent.

# LED Indicators

Status / Problems	LED indicators			LED Behavior
	Power	Temp	LED	
Standby	Orange solid	Off	Off	Power LED slow flash
Power warm up	Green blanking	Off	Off	
Power on	Green solid	Off	Off	Light solid on sequence: Power->Key->Ring & OK
Cooling	Orange blanking	Off	Off	Power LED slow flash
Fan I error	Off	Red solid	Off	
Templ error	Orange solid	Red solid	Red solid	

# Troubleshooting

## ? The projector does not turn on.

Cause	Remedy
There is no power from the power cable.	Plug the AC adapter into the DC IN socket on the projector, plug the power cord into the AC inlet on the AC adapter, plug the power cord into the power outlet. If the power outlet has a switch, make sure that it is switched on.
Attempting to turn the projector on again during the cooling process.	Wait until the cooling down process is complete.

## ? No picture

Cause	Remedy
The source is not turned on or the cable is not connected correctly.	Turn the source on and check that the signal cable is connected correctly.
The projector is not correctly connected to the input signal device.	Check the connection.
The input signal has not been correctly selected.	Select the correct input signal with the ◀/▶ key on the projector or remote control.

## ? Blurred image

Cause	Remedy
The projection lens is not correctly focused.	Adjust the focus of the lens using the focus ring.
The projector and the screen are not aligned properly.	Adjust the projection angle and direction as well as the height of the unit if necessary.

## ? Remote control does not work

Cause	Remedy
The battery is out of power.	Replace the battery with new one.
There is an obstacle between the remote control and the projector.	Remove the obstacle.
You are too far away from the projector.	Stand within 7 meters (23 feet) of the projector.

## ? The password is incorrect

Cause	Remedy
You do not remember the password.	Please see <a href="#">"Entering the password recall procedure" on page 32</a> for details.



# Specifications

## Projector specifications

 All specifications are subject to change without notice.

<b>General</b>	
Product name	Ultra Lite LED Projector
Model name	GP20
<b>Optical</b>	
Resolution	1280 x 800 WXGA
Display system	1-CHIP DMD
Lens F/Number	F = 1.65
Lamp	3LED
Throw Ratio	1.2:1 (60" +/- 3% @1.5 m)
<b>Electrical</b>	
Power supply	AC100–240V, 50-60 Hz (Automatic)
Power consumption	< 190 W (Max.); 0.5 W (Standby)
Keystone Adjustment	1D, Vertical +/- 30 degrees
<b>Mechanical</b>	
Dimensions	220 mm (W) x 61.8 mm (H) x 178.3 mm (D)
Weight	1.75 kg
<b>Input terminal</b>	
Multi-input	
Computer input	D-Sub 15-pin (female) x 1
Video input	VIDEO RCA jack x 1 SD/HDTV signal input Analog - Component RCA jack x 3 (through RGB input)
HDMI / MHL	HDMI / MHL x 1
Audio input	3.5 mm stereo mini jack x 1
USB-A type	For USB flash drive (2.0). Supports videos/photos/music/documents.
mini-B USB type	Supports USB display and USB file transfer
SD card slot	Supports videos/photos/music/documents
Internal memory	2GB
<b>Output terminal</b>	
Audio output	3.5 mm stereo mini jack x 1
Speaker	3 watt x 2
<b>Environmental Requirements</b>	
Operating temperature	0° C- 40° C at sea level

Operating relative humidity	10%-90% (without condensation)
Operating altitude	0-1499 m at 0°C-35°C 1500-3000 m at 0°C-30°C (with High Altitude Mode on)

## Dimensions

220 mm (W) x 61.8 mm (H) x 178.3 mm (D)

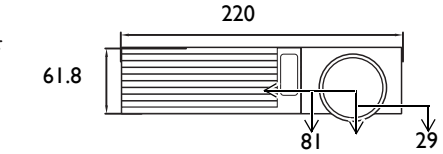
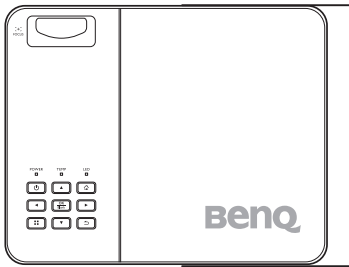

Unit: mm

# Timing chart

## Supported timing for PC input

Resolution	Mode	Vertical Frequency (Hz)	Horizontal Frequency (kHz)
640 x 480	VGA_60	59.940	31.469
	VGA_72	72.809	37.861
	VGA_75	75.000	37.500
	VGA_85	85.008	43.269
720 x 400	720 x 400_70	70.087	31.469
800 x 600	SVGA_60	60.317	37.879
	SVGA_72	72.188	48.077
	SVGA_75	75.000	46.875
	SVGA_85	85.061	53.674
	SVGA_120*	119.854	77.425
1024 x 768	XGA_60	60.004	48.363
	XGA_70	70.069	56.476
	XGA_75	75.029	60.023
	XGA_85	84.997	68.667
	XGA_120*(Reduce Blanking)	119.989	97.551
1152 x 864	1152 x 864_75	75.00	67.500
1024 x 576	BenQ Notebook Timing	60.0	35.820
1024 x 600	BenQ Notebook Timing	64.995	41.467
1280 x 720	1280 x 720_60	60	45.000
1280 x 768	1280 x 768_60	59.870	47.776
	1280 x 768_75	59.810	49.702
1280 x 800	WXGA_75	74.934	62.795
	WXGA_85	84.880	71.554
	WXGA_120*(Reduce Blanking)	119.909	101.563
	SXGA_60	60.020	63.981
1280 x 1024	SXGA_75	75.025	79.976
	1280 x 960_60	60.000	60.000
1280 x 960	1280 x 960_85	85.002	85.938
	1360 x 768_60	60.015	47.712
1440 x 900	WXGA+_60	59.887	55.935
1400 x 1050	SXGA+_60	59.978	65.317
1680 x 1050	1680 x 1050_60	59.954	65.290
640 x 480 @67Hz	MAC13	66.667	35.000
832 x 624@75Hz	MAC16	74.546	49.722
1024 x 768@75Hz	MAC19	75.020	60.241
1152 x 870@75Hz	MAC21	75.06	68.68

 \*Supported timing for 3D signal with frame sequential format.

## Supported timing for HDMI input

### PC timings:

Resolution	Mode	Vertical Frequency (Hz)	Horizontal Frequency (kHz)
640 x 480	VGA_60	59.940	31.469
	VGA_72	72.809	37.861
	VGA_75	75.000	37.500
	VGA_85	85.008	43.269
720 x 400	720 x 400_70	70.087	31.469
800 x 600	SVGA_60	60.317	37.879
	SVGA_72	72.188	48.077
	SVGA_75	75.000	46.875
	SVGA_85	85.061	53.674
	SVGA_120*	119.854	77.425
1024 x 768	XGA_60	60.004	48.363
	XGA_70	70.069	56.476
	XGA_75	75.029	60.023
	XGA_85	84.997	68.667
	XGA_120* (Reduce Blanking)	119.989	97.551
1152 x 864	1152 x 864_75	75.00	67.500
1024 x 576	BenQ Notebook Timing	60.000	35.820
1024 x 600	BenQ Notebook Timing	64.995	41.467
1280 x 720	1280 x 720_60	60	45.000
1280 x 768	1280 x 768_60	59.870	47.776
1280 x 800	WXGA_60	59.810	49.702
	WXGA_75	74.934	62.795
	WXGA_85	84.880	71.554
	WXGA_120* (Reduce Blanking)	119.909	101.563
1280 x 1024	SXGA_60	60.020	63.981
	SXGA_75	75.025	79.976
1280 x 960	1280 x 960_60	60.000	60.000
	1280 x 960_85	85.002	85.938
1360 x 768	1360 x 768_60	60.015	47.712
1440 x 900	WXGA+ 60	59.887	55.935
1400 x 1050	SXGA+ 60	59.978	65.317
1680 x 1050	1680 x 1050_60	59.954	65.290
640 x 480@67Hz	MAC13	66.667	35.000
832 x 624@75Hz	MAC16	74.546	49.772
1024 x 768@75Hz	MAC19	75.020	60.241
1152 x 870@75Hz	MAC21	75.06	68.68

 \*Supported timing for 3D signal with frame sequential format.

## Video timings:

Timing	Resolution	Vertical Frequency (Hz)	Horizontal Frequency (kHz)
480i	720 (1440) × 480	59.94	15.73
480p	720 × 480	59.94	31.47
576i	720 (1440) × 576	50	15.63
576p	720 × 576	50	31.25
720/50p	1280 × 720	50	37.5
720/60p	1280 × 720	60	45.00
1080/24P	1920 × 1080	24	27
1080/25P	1920 × 1080	25	28.13
1080/30P	1920 × 1080	30	33.75
1080/50i	1920 × 1080	50	28.13
1080/60i	1920 × 1080	60	33.75
1080/50P	1920 × 1080	50	56.25
1080/60P	1920 × 1080	60	67.5

## Supported timing for MHL input

Timing	Resolution	Vertical Frequency (Hz)	Horizontal Frequency (kHz)
480i	720 (1440) × 480	59.94	15.73
480p	720 × 480	59.94	31.47
576i	720 (1440) × 576	50	15.63
576p	720 × 576	50	31.25
720/50p	1280 × 720	50	37.5
720/60p	1280 × 720	60	45.00
1080/24P	1920 × 1080	24	27
1080/25P	1920 × 1080	25	28.13
1080/30P	1920 × 1080	30	33.75
1080/50i	1920 × 1080	50	28.13
1080/60i	1920 × 1080	60	33.75

## Supported timing for Component-YPbPr input

Timing	Resolution	Vertical Frequency (Hz)	Horizontal Frequency (kHz)
480i	720 × 480	59.94	15.73
480p	720 × 480	59.94	31.47
576i	720 × 576	50	15.63
576p	720 × 576	50	31.25
720/50p	1280 × 720	50	37.5
720/60p	1280 × 720	60	45.00
1080/50i	1920 × 1080	50	28.13
1080/60i	1920 × 1080	60	33.75
1080/24P	1920 × 1080	24	27
1080/25P	1920 × 1080	25	28.13
1080/30P	1920 × 1080	30	33.75
1080/50P	1920 × 1080	50	56.25
1080/60P	1920 × 1080	60	67.5

## Supported timing for Video input

Video mode	Vertical Frequency (Hz)	Horizontal Frequency (kHz)
NTSC	60	15.73
PAL	50	15.63
SECAM	50	15.63
PAL-M	60	15.73
PAL-N	50	15.63
PAL-60	60	15.73
NTSC4.43	60	15.73

# Warranty and Copyright information

## Patents

This BenQ projector is covered by the following patents:

U.S. patents 6,837,608; 7,275,834; 7,181,318; TW patents 202690; 205470; I228635; I259932; China Patents ( 中国发明专利 ) ZL01143168.7; ZL03119907.0; ZL200510051609.2

## Limited warranty

BenQ warrants this product against any defects in material and workmanship, under normal usage and storage.

Proof of purchase date will be required with any warranty claim. In the event this product is found to be defective within the warranty period, BenQ's only obligation and your exclusive remedy shall be replacement of any defective parts (labor included). To obtain warranty service, immediately notify the dealer from which you purchased the product of any defects.

Important: The above warranty shall be void if the customer fails to operate the product in accordance with BenQ's written instructions, especially the ambient humidity must be in-between 10% and 90%, temperature in-between 0°C and 35°C, altitude lower than 4920 feet, and avoiding to operate the projector in a dusty environment. This warranty gives you specific legal rights, and you may have other rights which vary from country to country.

For other information, please visit [www.BenQ.com](http://www.BenQ.com).

## Copyright

© 2013 BenQ Corp. Specification may vary by region, please visit your local stores for details. Actual product's features and specifications are subject to change without notice.

This material may include corporate names and trademarks of third parties which are the properties of the third parties respectively. Apple, the Apple logo, iPad, iPhone, iPod, iPod classic, iPod nano, iPod shuffle, and iPod touch are trademarks of Apple Inc., registered in the U.S. and other countries.

## Disclaimer

BenQ Corporation makes no representations or warranties, either expressed or implied, with respect to the contents hereof and specifically disclaims any warranties, merchantability or fitness for any particular purpose. Further, BenQ Corporation reserves the right to revise this publication and to make changes from time to time in the contents hereof without obligation to notify any person of such revision or changes.

\*DLP, Digital Micromirror Device and DMD are trademarks of Texas Instruments. Others are copyrights of their respective companies or organizations.