



User's Manual

FlexScan® EV2360

Color LCD Monitor

Important

Please read this "User's Manual", and "PRECAUTIONS" (separate volume) carefully to familiarize yourself with safe and effective usage.

-
- Refer to the "Setup Guide" for information on the installation / connection of the monitor.
 - For the latest product information including the "User's Manual", refer to our web site :
www.eizoglobal.com
-

Location of Caution Statement

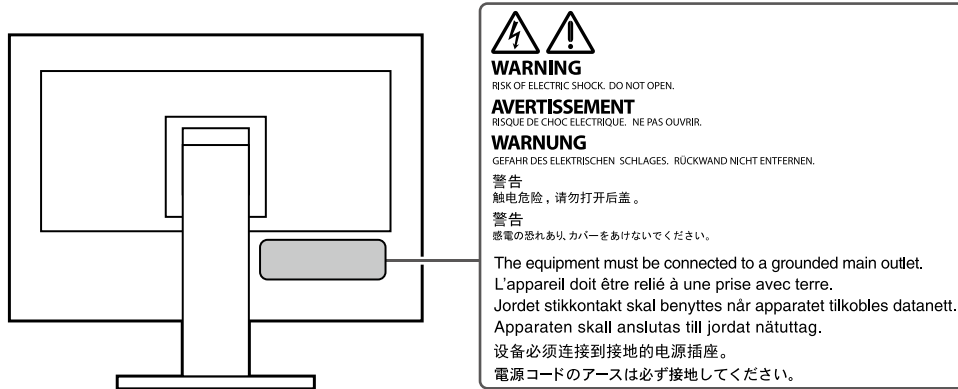

This product has been adjusted specifically for use in the region to which it was originally shipped. If operated outside this region, the product may not perform as stated in the specifications.

No part of this manual may be reproduced, stored in a retrieval system, or transmitted, in any form or by any means, electronic, mechanical, or otherwise, without the prior written permission of EIZO Corporation. EIZO Corporation is under no obligation to hold any submitted material or information confidential unless prior arrangements are made pursuant to EIZO Corporation's receipt of said information. Although every effort has been made to ensure that this manual provides up-to-date information, please note that EIZO monitor specifications are subject to change without notice.

Notice for this monitor

This product is suited to general purposes like creating documents, viewing multimedia content (Assuming usage of approximately 12 hours per day).

If using this product for the following kinds of applications, where an extremely high degree of reliability and safety is required, then measures should be in place to maintain safety while using this product.

- Transportation equipment (ships, aircraft, trains, and automobiles)
- Safety devices (Disaster prevention systems, security control systems, etc.)
- Life-critical devices (medical devices, such as life-support devices and operating room devices)
- Nuclear energy control devices (Nuclear energy control systems, security control systems of nuclear facilities, etc.)
- Major system communication devices (operation control systems of transportation systems, air traffic control systems, etc.)

This product has been adjusted specifically for use in the region to which it was originally shipped. If the product is used outside the region, it may not operate as specified in the specifications.

This product may not be covered by warranty for uses other than those described in this manual.

The specifications noted in this manual are only applicable when the following are used:

- Power cords provided with the product
- Signal cables specified by us

Only use optional products manufactured or specified by us with this product.

If you place this product on a lacquer-coated desk, the color may adhere to the bottom of the stand due to the composition of the rubber. Check the desk surface before use.

It takes about 30 minutes (under our measurement conditions) for the monitor display to stabilize. Please wait 30 minutes or more after the monitor power has been turned on, and then adjust the monitor.

Monitors should be set to a lower brightness to prevent a loss in the screen quality caused by long-term use and to maintain stable use.

When the screen image is changed after displaying the same image for extended periods of time, an afterimage may appear. Use the screen saver or power save function to avoid displaying the same image for extended periods of time. Depending on the image, an afterimage may appear even if it was displayed for a short period of time. To remove such a phenomenon, change the image or keep the power turned off for several hours.

If the monitor displays continuously over a long period of time, dark smudges or burn-in may appear. To maximize the life of the monitor, we recommend the monitor be turned off periodically.

Periodic cleaning is recommended to keep the monitor looking new and to prolong its operation lifetime (refer to [“Cleaning” \(page 4\)](#)).

The LCD panel is manufactured using high-precision technology. Although, missing pixels or lit pixels may appear on the LCD panel, this is not a malfunction. Percentage of effective dots: 99.9994 % or higher.

The backlight of the LCD panel has a fixed lifetime. Depending on the usage pattern, such as usage for long continuous periods, the lifespan of the backlight may run out sooner, requiring replacement. When the screen becomes dark or begins to flicker, please contact your local EIZO representative.

Do not press on the LCD panel or edge of the frame strongly, as this may result in display malfunctions, such as interference patterns, etc. If pressure is continuously applied to the LCD panel surface, the liquid crystal may deteriorate or the LCD panel may be damaged. (If the pressure marks remain on the panel, leave the monitor with a black or white screen. The symptom may disappear.)

Do not scratch or press on the LCD panel with any sharp objects, at this may result in damage to the LCD panel. Do not attempt to brush with tissues as this may scratch the panel.

When the monitor is cold and brought into a room or the room temperature goes up quickly, dew condensation may occur on the interior and exterior surfaces of the monitor. In that case, do not turn the monitor on. Instead wait until the dew condensation disappears, otherwise it may cause some damage to the monitor.

Cleaning

The stains on the cabinet and LCD panel surface can be removed by moistening part of a soft cloth with water or by using ScreenCleaner (available as an option).

Attention

- Chemicals such as alcohol and antiseptic solution may cause gloss variation, tarnishing, and fading of the cabinet or LCD panel, and also quality deterioration of the image.
 - Never use thinner, benzine, wax, or abrasive cleaner as they may damage the cabinet or LCD panel surface.
-

To use the monitor comfortably

- An excessively dark or bright screen may affect your eyes. Adjust the brightness of the monitor according to the environmental conditions.
- Staring at the monitor for a long time tires your eyes. Take a 10-minute rest every hour.

CONTENTS

Notice for this monitor	3	Chapter 5 Troubleshooting.....	28
Cleaning	4	5-1. No Picture	28
To use the monitor comfortably	4	5-2. Imaging Problems (Both Digital and Analog)	29
CONTENTS.....	5	5-3. Imaging Problems (For Analog Only)	30
Chapter 1 Introduction.....	6	5-4. Other Problems	31
1-1. Features	6	Chapter 6 Attaching/Removing the Stand	32
● High Degree of Flexibility for Installation	6	6-1. Removing the Stand	32
● Reduction of Power Consumption	7	6-2. Attaching the Optional Arm.....	33
● Realizing More Convenient Operations Using Screen InStyle	7	6-3. Attaching the original stand.....	34
1-2. Controls and Functions	8	6-4. Removing the Stand Base	35
● Front	8	6-5. Attaching the Stand Base	36
● Rear	9	Chapter 7 Reference	37
1-3. Supported Resolutions	10	7-1. Connecting Multiple PCs	37
1-4. Changing the Computer Display Settings	11	● Connection examples	37
● Windows 10	11	7-2. Using the USB Hub Function.....	38
● Windows 8.1 / Windows 7	11	● Connection procedure.....	38
● macOS	11	7-3. Specifications	39
Chapter 2 Basic Adjustment / Setting	12	● Accessories	40
2-1. Switch Operation Method	12	Appendix	41
2-2. Switching Input Signals	12	Trademark	41
2-3. Switching Display Modes (Color Modes)...	13	License	41
● Display Modes.....	13		
2-4. Conserving Energy	14		
2-5. Adjusting Brightness	15		
2-6. Adjusting Volume.....	15		
Chapter 3 Advanced Adjustment / Setting	16		
3-1. Basic Operation of the Setting Menu	16		
3-2. Setting Menu Functions	17		
● Color Adjustment.....	17		
● Signal Settings	20		
● Preference Settings	23		
● Language	24		
● Information	24		
Chapter 4 Administrator Settings.....	25		
4-1. Basic Operation of the “Administrator Settings” Menu.....	25		
4-2. Functions of the “Administrator Settings” Menu.....	26		

Chapter 1 Introduction

Thank you very much for choosing an EIZO color LCD monitor.

1-1. Features

● High Degree of Flexibility for Installation

- This product can be used as an external monitor of a notebook computer.

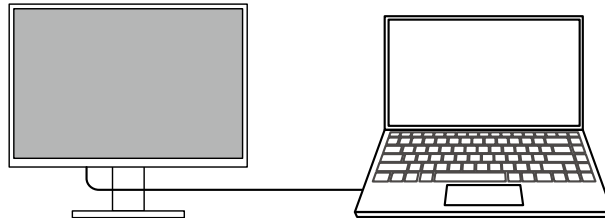

- By attaching the monitor to an arm, the screen can be rotated 180° (upward-downward rotation) and used in a multi-monitor configuration.

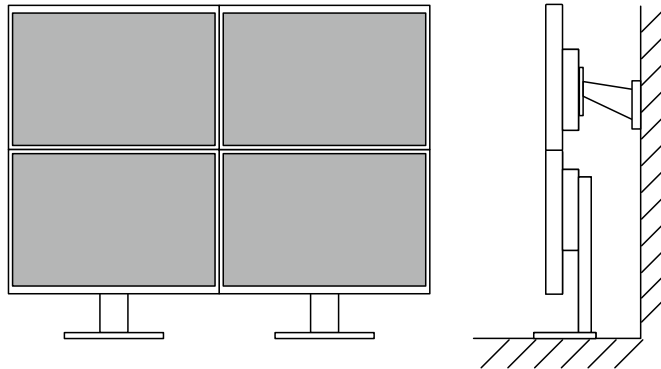

Note

- In order to rotate the display of the monitor 180°, it is necessary to configure the settings for the computer.
-

● Reduction of Power Consumption

This product provides a function that automatically adjusts the screen brightness to reduce power consumption *1. Power Reduction, CO₂ Reduction, and Eco Performance Level can be checked on the "EcoView Settings" menu. (page 14)

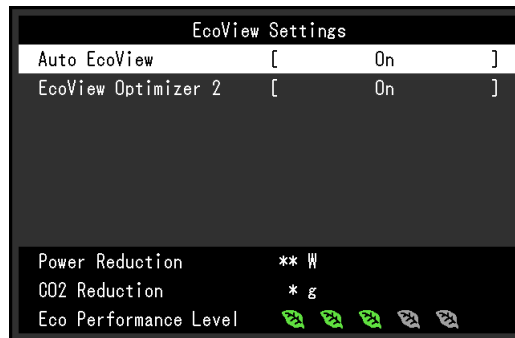

- Auto EcoView

The ambient light sensor on the front of the monitor detects the ambient brightness to automatically adjust the screen brightness to a comfortable level.

- EcoView Optimizer 2

The monitor automatically adjusts the screen brightness according to the white level of the input signal. This function can reduce power consumption while maintaining the brightness specified by the input signal.

*1 Reference values

Maximum power consumption: 37 W (when a USB device is connected and the speakers are working),
standard power consumption: 11 W (brightness 120 cd/m², when no USB device is connected and the speakers are not working, at default settings)

● Realizing More Convenient Operations Using Screen InStyle

The "Screen InStyle" monitor control utility enables you to use the monitor more conveniently.

- The monitor color mode can be switched automatically to suit the software to be used.
- When multiple monitors are installed, you can turn the power on and off or change the color mode of all monitors at the same time.

Note

- Screen InStyle can be downloaded from our web site (www.eizoglobal.com).
 - The Windows operating systems are only supported.
-

1-2. Controls and Functions

● Front

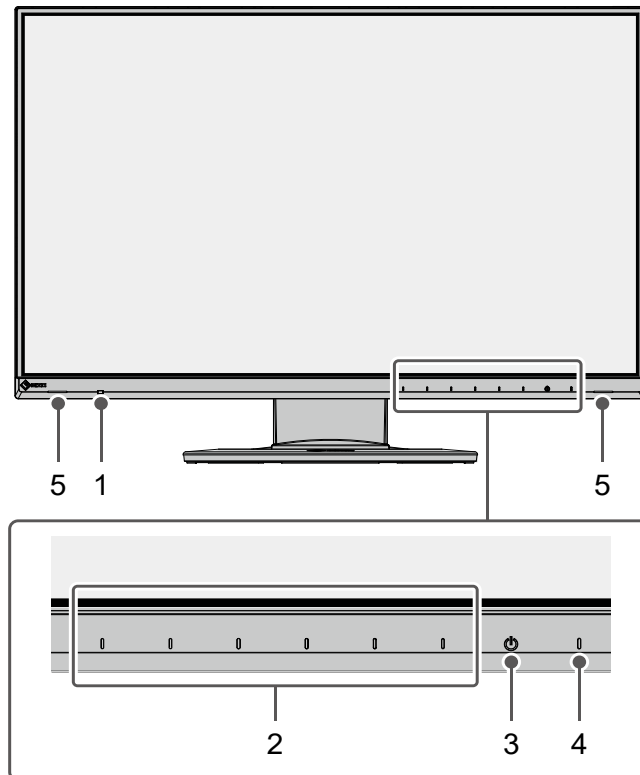

1. Ambient light sensor	Detects ambient brightness. If you use Auto EcoView, the screen brightness is automatically adjusted according to the ambient brightness (page 14).
2. Operation switches	Displays menus. Operate the switches according to the operation guide (page 16).
3. Power switch	Turns the power on or off.
4. Power indicator	Indicates the monitor's operation status. White: Normal operation mode Orange: Power saving mode OFF: Main power / power off
5. Speakers	Outputs audio.

● Rear

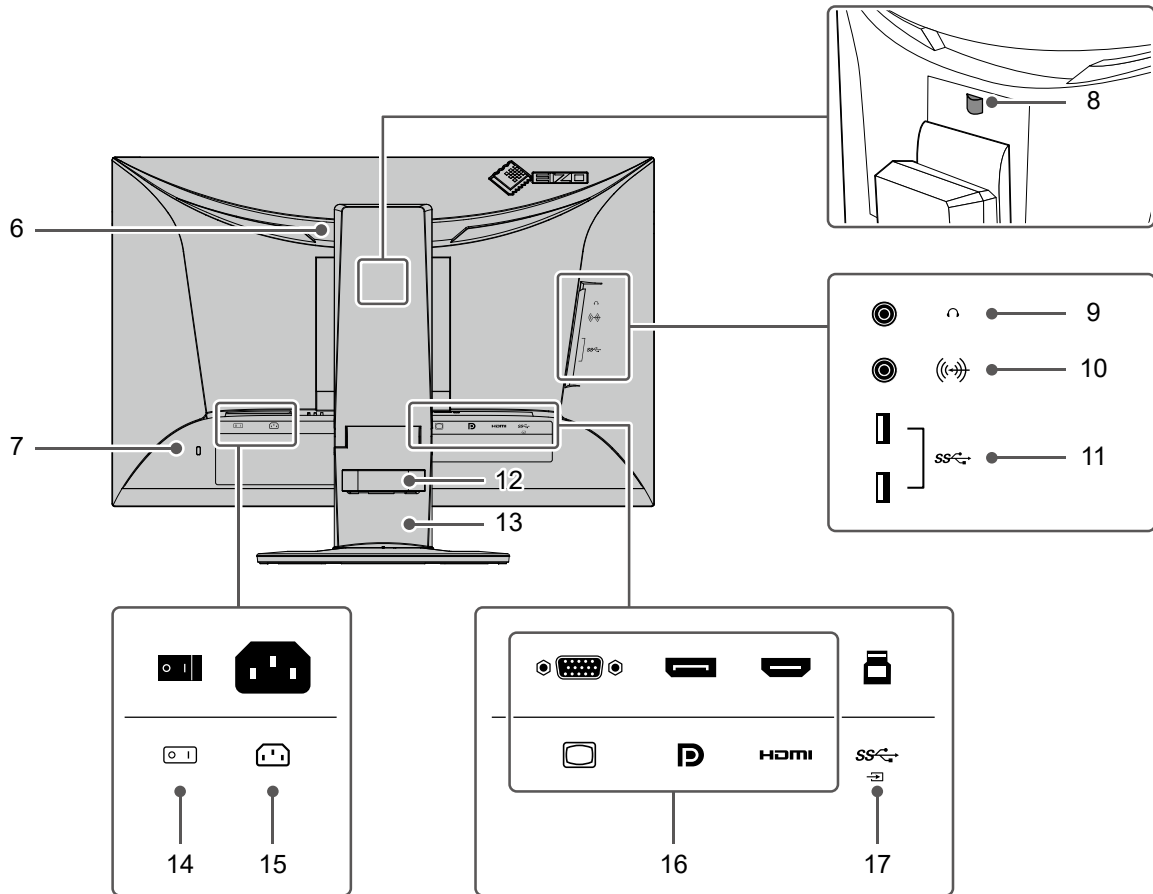

6. Handle	This handle is used for transportation.
7. Security lock slot	Complies with Kensington's MicroSaver security system.
8. Lock button	Use this button to remove the monitor from the stand.
9. Headphone jack	Connects to headphones.
10. Stereo mini jack	If you connect an external device using the stereo mini jack cable, external audio can be output from the monitor.
11. USB Type-A connector (USB downstream port)	Connects to a peripheral USB device (page 38).
12. Cable holder	Holds the monitor cables.
13. Stand^{*1}	Adjusts the height and angle (tilt and swivel) of the monitor.
14. Main power switch	Turns the main power on or off. : On, ○ : Off
15. Power connector	Connects the power cord.
16. Input signal connectors	The following connectors are available on the monitor rear in order of left to right. D-Sub mini 15-pin connector DisplayPort connector HDMI connector
17. USB Type-B connector (USB upstream port)	Connect the USB cable when using software that requires USB connection or when using the USB hub function (page 38).

*1 An optional arm (or optional stand) can be attached by removing the stand section.

1-3. Supported Resolutions

The monitor supports the following resolutions.

Resolution	Vertical Scan Frequency	Scan Format	D-Sub	DisplayPort	HDMI
640 × 480	59.940 Hz	Progressive	√	√	√
640 × 480	60.000 Hz	Progressive	-	√	√
720 × 400	70.087 Hz	Progressive	√	√	√
720 × 480	59.940 Hz	Progressive	-	√	√
720 × 480	60.000 Hz	Progressive	-	√	√
720 × 576	50.000 Hz	Progressive	-	-	√
800 × 600	60.317 Hz	Progressive	√	√	√
1024 × 768	60.004 Hz	Progressive	√	√	√
1280 × 720	50.000 Hz	Progressive	-	-	√
1280 × 720	59.940 Hz	Progressive	-	√	√
1280 × 720	60.000 Hz	Progressive	√	√	√
1280 × 800	59.810 Hz	Progressive	√	√	√
1280 × 1024	60.020 Hz	Progressive	√	√	√
1600 × 900	60.000 Hz	Progressive	√	√	√
1600 × 1200	60.000 Hz	Progressive	√	√	√
1680 × 1050	59.883 Hz	Progressive	√	√	√
1680 × 1050	59.954 Hz	Progressive	√	√	√
1920 × 1080	50.000 Hz	Progressive	-	-	√
1920 × 1080	59.940 Hz	Progressive	-	√	√
1920 × 1080	60.000 Hz	Progressive	√	√	√
1920 × 1200 ^{*1}	59.885 Hz	Progressive	-	-	√
1920 × 1200 ^{*1}	59.950 Hz	Progressive	√	√	√

*1 Recommended resolution

1-4. Changing the Computer Display Settings

If the image is not displayed properly after connecting the monitor to a PC, follow the procedure below to change the display settings on the computer.

● Windows 10

1. Right-click the mouse anywhere on the desktop except on icons. A menu is displayed.
2. From the displayed menu, click “Display Settings”. The “Settings” screen is displayed.
3. If multiple monitors, including notebook PC screens, are connected to the computer, select “Extend these displays” in the “Multiple displays” menu, and then click “Keep changes” on the confirmation screen. After changing the settings, select a monitor in the “Select and rearrange displays” menu.
4. Select the “Make this my main display” option in the “Multiple displays” menu. This enables the monitor to display images properly.
5. Confirm that the recommended resolution for the monitor is set in the “Resolution” menu. (“(Recommended)” is displayed after the resolution.)
6. To change the size of text and icons, select a magnification in the menu of zoom percentages according to personal preference.
7. If a message prompting you to sign out is displayed after changing the settings, sign out and then sign in again.

● Windows 8.1 / Windows 7

* For Windows 8.1, click the “Desktop” tile on the Start Screen to display the desktop.

1. Right-click the mouse anywhere on the desktop except on icons. A menu is displayed.
2. From the displayed menu, click “Screen resolution”. The settings screen is displayed.
3. If multiple monitors, including notebook PC screens, are connected to the computer, select “Extend these displays” in the “Multiple displays” menu, and then click “Apply”. Click “Keep changes” on the confirmation screen.
4. Select a monitor in the “Display” menu, and then select the “Make this my main display” option and click “Apply”. This enables the monitor to display images properly.
5. Confirm that the recommended resolution for the monitor is set in the “Resolution” menu. (“(recommended)” is displayed after the resolution.)
6. To change the size of text and icons, click “Make text and other items larger or smaller”, select a size according to personal preference on the settings screen, and then click “Apply”.
7. If a message prompting you to sign out/log off is displayed after changing the settings, sign out/log off and then sign in/log in again.

● macOS

1. Select “System Preferences” from the Apple menu.
2. When the “System Preferences” panel is displayed, click “Displays”.
3. If multiple monitors, including notebook PC screens, are connected to the computer, make sure that “Mirror Displays” is not selected on the “Arrangement” tab. If it is selected, remove the check mark.
4. Select the “Display” tab, and make sure that “Default for display” is selected for “Resolution”. If it is not selected, add a check mark. The correct resolution has now been set for your display. Close the “System Preferences” panel. If multiple monitors, including notebook PC screens, are connected to the computer, configure these settings in “Display” on each monitor.
5. To select a resolution according to personal preference, select “Scaled” and then select a resolution (either from a list or icons), and then close the panel.

Chapter 2 Basic Adjustment / Setting

This product enables users to change the brightness according to personal preference or to suit the usage environment, and to reduce power consumption to conserve energy.

This chapter describes the basic functions that can be adjusted and set using the switches on the front of the monitor.

For advanced adjustment and setting procedures using the Setting menu, see “[Chapter 3 Advanced Adjustment / Setting](#)” (page 16).



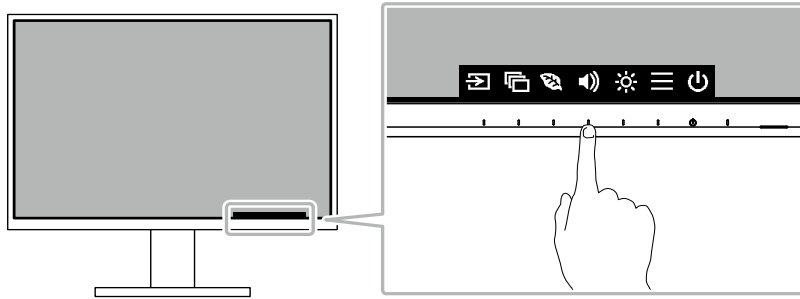

2-1. Switch Operation Method

1. Displaying the operation guide

1. Touch any switch (except )
The operation guide appears on the screen.



2. Adjusting / setting

1. Touch a switch for adjustment / setting.
The Adjustment / Setting menu appears.
(A submenu may also be displayed. In this case, select the item for adjustment / setting using   and select .)
2. Perform adjustment / setting with the switches and select  to accept the changes.

3. Exiting

1. Select  to exit the menu.

2-2. Switching Input Signals

When a monitor has multiple signal inputs, the signal to display on-screen can be changed.

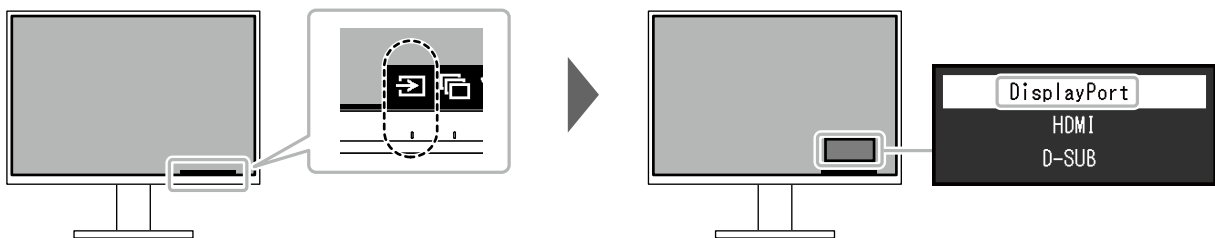

Note

- "Screen InStyle" allows you to switch input signals using the shortcut keys on the keyboard.

2-3. Switching Display Modes (Color Modes)

This product is preinstalled with color modes for various display purposes.

By switching the mode according to the purpose and contents of the display, you can display images in an appropriate manner.

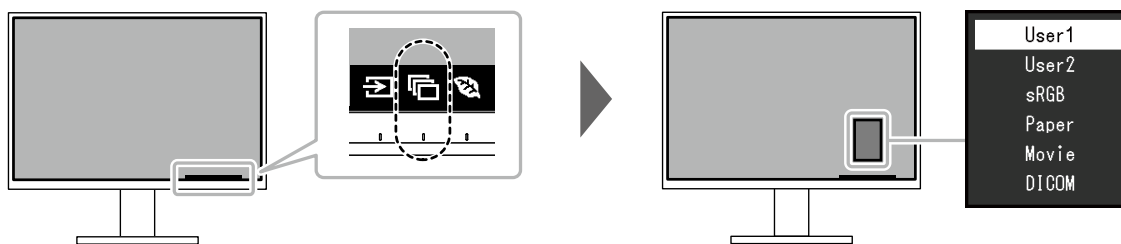

● Display Modes

Color Mode	Purpose
User1 User2	Select either of these modes to set a user-defined display mode.
sRGB	This mode is suitable for matching color reproduction with peripheral devices that support sRGB, such as when printing photos taken using a digital camera.
Paper	This mode uses color tones and contrast similar to that of paper to produce a printed paper effect. It is suitable for displaying images from media such as books and documents.
Movie	This mode displays moving images brightly and with a clear-cut three-dimensional appearance. It is suitable for playing back video content.
DICOM	Select this mode to simply display medical purpose digital images based on DICOM® Part 14. Attention • This is not intended to be used for diagnostic purposes.

Note

- "Screen InStyle" allows you to select the color mode automatically according to the software in use.
- In Paper mode, the amount of blue light emitted from the screen is reduced by changing the color tone and controlling the brightness.

2-4. Conserving Energy

This monitor is equipped with EcoView functions to enable users to conserve energy.

If you use Auto EcoView, which is one of the EcoView functions, the screen brightness is automatically adjusted according to the ambient brightness.

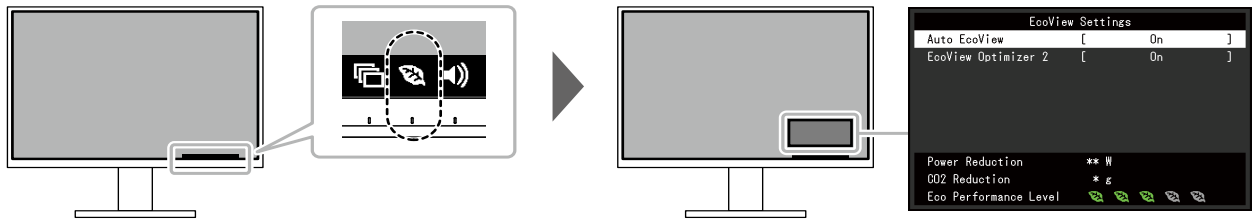

Function	Setting Value	Description
Auto EcoView	On Off	<p>The ambient light sensor on the front of the monitor detects the ambient brightness to automatically adjust the screen brightness to a comfortable level using Auto EcoView. The power consumption of the backlight can be curtailed by adjusting the brightness to an appropriate level.</p> <p>This function can also mitigate eye strain and tiredness caused by a screen that is too bright or too dark.</p> <p>Note</p> <ul style="list-style-type: none"> • Be careful not to block the ambient light sensor on the lower side of the monitor when using Auto EcoView. • Even when Auto EcoView is set to "On", you can change the brightness of the monitor using the operation switches () on the front of the monitor or in the color adjustment settings. The manner in which Auto EcoView changes the brightness will also vary depending on the value you set. • When "DICOM" is selected for the color mode, the Auto EcoView setting is turned "Off".
EcoView Optimizer 2	On Off	<p>The monitor automatically adjusts the screen brightness according to the white level of the input signal. This function can reduce power consumption while maintaining the brightness specified by the input signal.</p> <p>Note</p> <ul style="list-style-type: none"> • The setting is turned "Off" in the following cases: <ul style="list-style-type: none"> - "Movie" or "DICOM" is selected for the color mode • When set to "On", the appearance of pale colors may change. If this bothers you, set this function to "Off".

Note

- The power saving level (Power Reduction, CO₂ Reduction, and Eco Performance Level) can be checked on the "EcoView Settings" menu. The more indicators that light up representing the Eco Performance Level, the higher the power saving level attained.
 - Power Reduction: the reduction in the backlight's power consumption as a result of the adjusted brightness value.
 - CO₂ Reduction: converted from the "Power Reduction" value, this is an estimate of the quantity of CO₂ emissions reduced when using the monitor for 1 hour.
- The numeric value is a result of calculation based on a default setting (0.000555t-CO₂ / kWh) determined by a Japanese ministerial ordinance (2006, Ministry of Economy, Trade and Industry, Ministry of Environment, civil code article 3) and may differ depending on country and year.

2-5. Adjusting Brightness

The brightness of the screen can be adjusted to suit the installation environment or personal preference. The screen brightness is adjusted by changing the brightness of the backlight (light source from the LCD back panel).

Setting Value

0 to 100

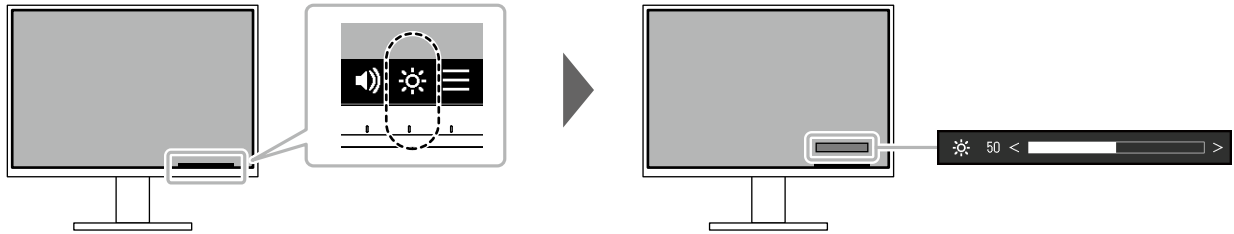

2-6. Adjusting Volume

The volume of the speakers and headphones can be set individually.

Setting Value

0 to 30

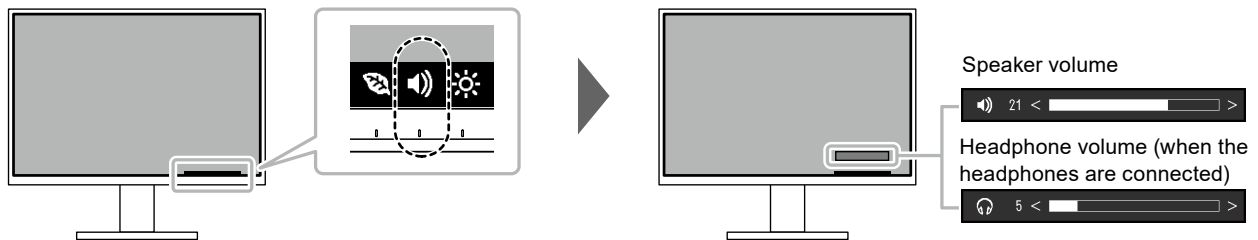



Chapter 3 Advanced Adjustment / Setting

This chapter describes the advanced monitor adjustment and setting procedures using the Setting menu. For basic functions, see “Chapter 2 Basic Adjustment / Setting” (page 12).



3-1. Basic Operation of the Setting Menu

1. Menu display

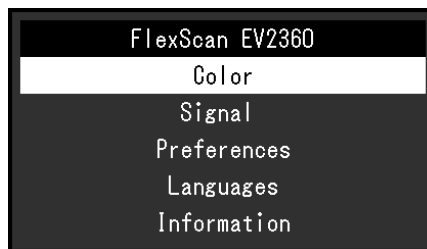

1. Touch any switch (except )
The operation guide appears.
2. Select 
The Setting menu appears.





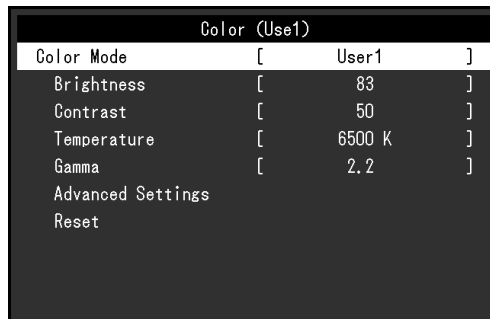



2. Adjusting / setting

1. Select a menu to adjust / set with   and select 
The Sub menu appears.



2. Select an item to adjust / set with   and select 
The Adjustment / Setting menu appears.



3. Perform adjustment / setting with   or   and select  to accept the changes.
The Sub menu appears.
Selecting  during adjustment / setting will cancel the adjustment / setting and restore the state prior to making changes.

3. Exiting

1. Selecting  several times will terminate the Setting menu.

3-2. Setting Menu Functions

● Color Adjustment

The color mode settings can be adjusted according to personal preference.

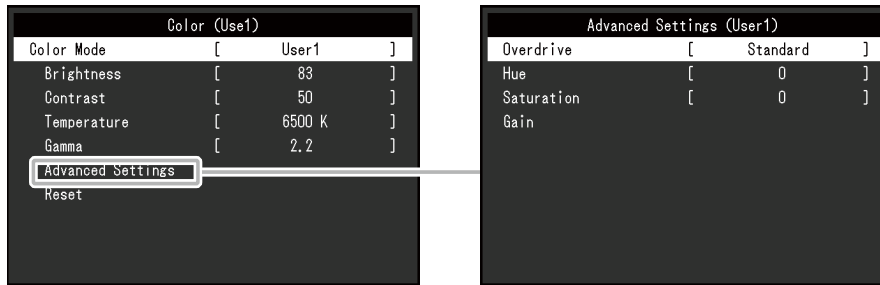

Functions that can be adjusted differ depending on the color mode.

√: Adjustable - : Not adjustable

Function	Color Mode				
	User1 User2	sRGB	Paper	Movie	DICOM
Brightness	√	√	√	√	-
Contrast	√	-	-	√	-
Temperature	√	-	√	√	-
Gamma	√	-	-	-	-
Advanced Settings	Overdrive	√	-	-	-
	Hue	√	-	-	√
	Saturation	√	-	-	√
	Gain	√	-	-	-
Reset	√	√	√	√	-

Attention

- It takes about 30 minutes for the monitor display to stabilize. Please wait 30 minutes or more after power to the monitor has been turned on before adjusting the monitor.
- The same image may be observed in different colors on multiple monitors due to monitor-specific characteristics. Follow the procedure below to adjust and match colors across multiple monitors.
 1. Display a white screen on each monitor.
 2. Use one of the monitors as a visual reference point to make adjustments to the “Brightness”, “Temperature”, and “Gain” of the other monitors.
- When Auto EcoView is set to “On”, the same brightness setting is shared by all of the color modes and cannot be set individually for each color mode.

Function	Setting Value	Description
Color Mode	User1 User2 sRGB Paper Movie DICOM	Select the desired mode according to the monitor application. The color mode settings can also be adjusted according to personal preference. Select the mode for adjustment and perform adjustment using the relevant functions. Note <ul style="list-style-type: none"> For details on the adjustment status of each mode, see “2-3. Switching Display Modes (Color Modes)” (page 13).
Brightness	0 to 100	The screen brightness is adjusted by changing the brightness of the backlight (light source from the LCD back panel). Note <ul style="list-style-type: none"> If the image is too dark even when the brightness is set to 100, adjust the contrast.
Contrast	0 to 100	The brightness of the screen is adjusted by varying the video signal level. Note <ul style="list-style-type: none"> A contrast of 50 displays every color gradation. When adjusting the monitor, it is recommended to perform brightness adjustment, which does not lose gradation characteristics, prior to contrast adjustment. Perform contrast adjustment in the following cases. <ul style="list-style-type: none"> If the image is too dark even when the brightness is set to 100 (Set the contrast to higher than 50.)
Temperature	Off 4000 K to 10000 K (in increments of 500 K. 9300 K is included.)	Adjust the color temperature. The color temperature is normally used to express the hue of “White” and/or “Black” with a numerical value. The value is expressed in degrees “K” (Kelvin). The screen becomes reddish at low color temperatures and bluish at high color temperatures, similar to the temperatures of a flame. A gain preset value is set for each color temperature setting value. Note <ul style="list-style-type: none"> The value shown in “K” is available only as a reference. “Gain” allows you to perform more advanced adjustment. If set to “Off”, the image is displayed in the preset color of the LCD panel (Gain: 100 for each RGB channel). When the gain is changed, the color temperature setting changes to “Off”.
Gamma	1.8 2.0 2.2 2.4	Adjust the gamma. While the brightness of the monitor varies depending on the input signal, the variation rate is not proportional to the input signal. Maintaining the balance between the input signal and brightness of the monitor is referred to as “Gamma correction”. Note <ul style="list-style-type: none"> If “sRGB” is selected for the color mode, “sRGB” is displayed for the gamma value. If “Paper” is selected for the color mode, “Paper” is displayed for the gamma value. If “DICOM” is selected for the color mode, “DICOM” is displayed for the gamma value.

Function		Setting Value	Description
Advanced Settings	Overdrive	Enhanced Standard Off	<p>This function allows you to set the overdrive intensity based on the use of the monitor. Image lag can be reduced by using the “Enhanced” setting when displaying moving images.</p> <p>Note</p> <ul style="list-style-type: none"> Depending on the display resolution and the setting of “Picture Expansion” (page 20), overdrive may be set to “Off”.
	Hue	-50 to 50	<p>Adjust the hue.</p> <p>Note</p> <ul style="list-style-type: none"> Using this function may prevent some color gradations from being able to be displayed.
	Saturation	-50 to 50	<p>Adjust the color saturation.</p> <p>Note</p> <ul style="list-style-type: none"> Using this function may prevent some color gradations from being able to be displayed. The minimum value (-50) changes the screen to monochrome.
	Gain	0 to 100	<p>The brightness of each red, green, and blue color component is referred to as “Gain”. The hue of “white” can be changed by adjusting the gain.</p> <p>Note</p> <ul style="list-style-type: none"> Using this function may prevent some color gradations from being able to be displayed. The gain value changes according to the color temperature. When the gain is changed, the color temperature setting changes to “Off”.
Reset	-	Reset any color adjustments for the currently selected color mode back to the default settings.	

● Signal Settings

Set the details regarding input signal, such as the screen display size and color format.

- For D-Sub input



- For DisplayPort input

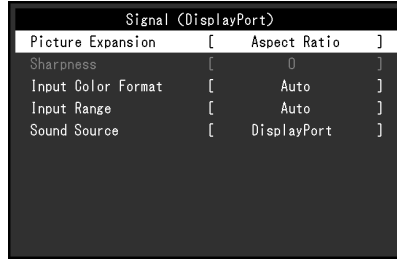

Function	Setting Value	Description
Picture Expansion	Auto *1 Full Screen Aspect Ratio Dot by Dot	<p>The screen size of the monitor display can be changed.</p> <ul style="list-style-type: none"> • “Auto” The monitor automatically changes the screen size according to the aspect ratio and resolution information from the PC. • “Full Screen” Images are stretched to full screen. Since aspect ratios are not maintained, images may be distorted in some cases. • “Aspect Ratio” Images are enlarged to full screen without changing the aspect ratio. Since aspect ratios are maintained, blank horizontal or vertical borders may appear. • “Dot by Dot” Displays the image at the set resolution or size specified by the input signal. <p>Note</p> <ul style="list-style-type: none"> • Example settings <ul style="list-style-type: none"> - Full Screen - Aspect Ratio - Dot by Dot (input signal)

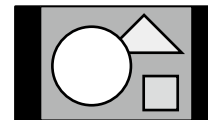
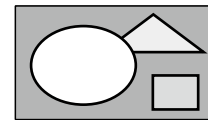

Function	Setting Value	Description
Sharpness	-2 to 2	<p>When a low resolution image is displayed using picture expansion mode ("Full Screen" or "Aspect Ratio"), the text and lines of the image may appear blurry. This blurriness can be reduced by configuring the settings for sharpness.</p> <p>Note</p> <ul style="list-style-type: none"> For some resolutions, it is not necessary to configure the settings for sharpness. ("Sharpness" is not a value that can be selected.)
Input Color Format	Auto YUV 4:2:2 ^{*1} YUV 4:4:4 ^{*1} YUV ^{*2} RGB	<p>The color format of the input signal can be specified. Try changing this setting if colors are not displayed correctly.</p> <p>Note</p> <ul style="list-style-type: none"> Setting is available only for DisplayPort and HDMI input. This setting is required when a DVI device is connected to the monitor via the HDMI connector port using a DVI-HDMI conversion connector.
Input Range	Auto Full Limited	<p>Depending on the PC, black and white of the video level of the signal output to the monitor may be limited. If a limited signal is displayed on the monitor, black will appear faint and white will appear dull, leading to a reduction in contrast. The output range of such signals can be extended to match the actual contrast ratio of the monitor.</p> <ul style="list-style-type: none"> "Auto" Automatically identifies the brightness range of the input signal and displays the image accordingly. "Full" Extension of the signal output range is not performed. "Limited" Extends the signal output range through 0 to 255 and displays the image. <p>Note</p> <ul style="list-style-type: none"> Setting is available only for DisplayPort and HDMI input. When "YUV" is selected in "Input Color Format", the setting is automatically set to "Limited". Additionally, when "Auto" is selected and the monitor determines the input color format to be YUV, the setting is automatically set to "Limited".
Sound Source	Stereo Mini Jack DisplayPort ^{*2} HDMI ^{*3}	<p>For DisplayPort signal input and HDMI signal input, the sound source can be changed.</p> <p>Note</p> <ul style="list-style-type: none"> For HDMI signal input without an audio signal, and D-Sub signal input, the setting is automatically set to "Stereo Mini Jack".

*1 Only enabled during HDMI input

*2 Only valid for DisplayPort input

*3 Only available for HDMI input with an audio signal

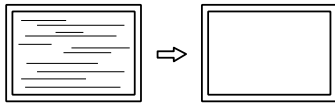
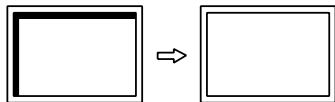
Function		Description
Analog Adjustment* ⁴	Auto Screen Adjust	<p>Screen flickering, display position, and size can be adjusted automatically. Selecting "Auto Screen Adjust" displays a message. Select "Yes" to enable this function.</p> <p>Note</p> <ul style="list-style-type: none"> The automatic screen adjustment function works correctly when an image is fully displayed over the entire displayable area of the screen. It does not work properly in the following cases: <ul style="list-style-type: none"> When an image is only displayed on part of the screen (command prompt window, for example) When a black background (wallpaper, etc.) is used <p>Also, this function may not work properly with some graphic boards.</p> <ul style="list-style-type: none"> When a signal is input into the monitor for the first time or when a resolution or vertical/horizontal scan frequency not used before is set, adjustment is performed automatically (only for signals with a resolution of 800×600 (SVGA) or higher).
	Auto Range Adjust	<p>Every color gradation (0 to 255) can be displayed by automatically adjusting the signal output level. Selecting "Auto Range Adjust" displays a message. Select "Yes" to enable this function.</p>
	Clock	<p>Flickering of vertical lines on the screen or part of the screen can be reduced.</p>  <p>Note</p> <ul style="list-style-type: none"> It is easy to miss the point where the settings are correct. Adjust this setting carefully.
	Phase	<p>Flickering and blurring over the entire screen can be reduced.</p>  <p>Note</p> <ul style="list-style-type: none"> Flickering and blurring may not be completely eliminated depending on your PC or graphics board. After setting, adjust the "Clock" again if vertical bars appear.
Hor. Position Ver. Position	<p>The display position (horizontal and vertical) of the screen can be adjusted.</p>  <p>Note</p> <ul style="list-style-type: none"> Since the number of pixels and pixel positions are fixed on the LCD monitor, only one position is provided to display images correctly. Position adjustment is made to shift an image to the correct position. 	

*4 Only valid for D-Sub input

● Preference Settings

The monitor's settings can be configured to suit the usage environment or personal preference.

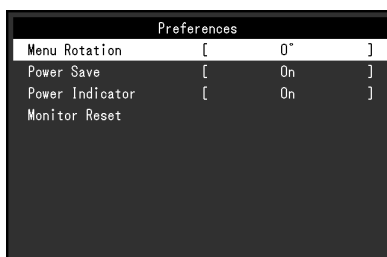

Function	Setting Value	Description
Menu Rotation	0° 90° 270°	<p>When the monitor is used in a vertical position, the direction of the Setting menu can also be changed.</p> <p>Note</p> <ul style="list-style-type: none"> • Check whether the cables are connected properly. • It is necessary to configure the settings of the computer to use the monitor vertically. For details, refer to our website (www.eizoglobal.com). • The menu cannot be rotated 180°. When rotating a monitor 180°, perform the adjustments / settings for the monitor before rotating it.
Power Save	On Off	<p>The monitor can be set to enter power saving mode according to the state of the PC.</p> <p>The monitor changes to power saving mode about 15 seconds after signal input ceases to be detected.</p> <p>When the monitor has shifted to power saving mode, images are not displayed on the screen.</p> <ul style="list-style-type: none"> • How to exit power saving mode <ul style="list-style-type: none"> - Press the operation switches (excluding ⏻) on the front of the monitor - The monitor automatically exits power saving mode when the monitor receives input <p>Note</p> <ul style="list-style-type: none"> • At the time of shifting to power saving mode, a message that indicates the transition is displayed 5 seconds in advance. • When not using the monitor, you can turn off the main power supply or disconnect the power plug so that the power is cut completely. • When the monitor is in power saving mode, devices connected to the USB downstream port will still work. Therefore, power consumption of the monitor varies with connected devices even in power saving mode. • The amount of power consumption also varies while the stereo mini jack cable is connected.
Power Indicator	On Off	The power indicator (white) can be turned off in normal operation mode.
Monitor Reset	-	<p>Restore all settings to their default values except for the following settings.</p> <ul style="list-style-type: none"> • Settings on the “Administrator Settings” menu

● Language

The display language for menus and messages can be selected.

Setting Value

English, German, French, Spanish, Italian, Swedish, Japanese, Simplified Chinese, Traditional Chinese



Attention

- The display language of the "Administrator Settings" menu cannot be changed.
-

● Information

Monitor information (product name, serial number, firmware version, usage time, resolution, and input signal) can be checked.

Example:

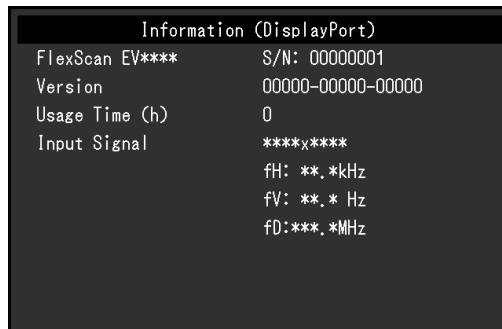



Chapter 4 Administrator Settings

This chapter describes how to configure monitor operation using the “Administrator Settings” menu.

4-1. Basic Operation of the “Administrator Settings” Menu

1. Menu display

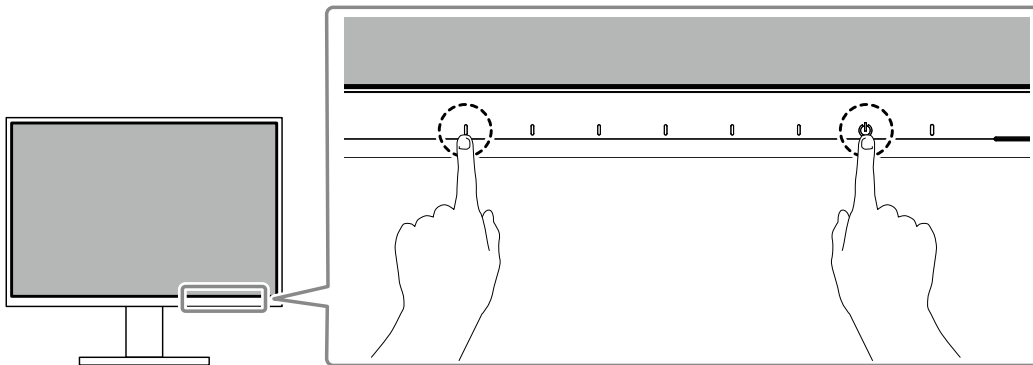

1. Touch  to turn off the monitor.
2. While touching the leftmost switch, touch  for more than 2 seconds to turn on the monitor.

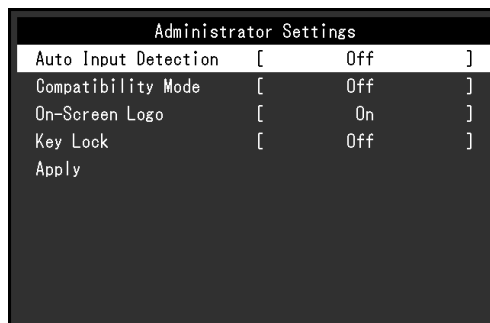

The “Administrator Settings” menu appears.



2. Setting

1. Select an item to set with   and select .

The Adjustment / Setting menu appears.

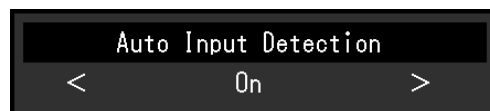

2. Set with   and select .

The “Administrator Settings” menu appears.

3. Applying and exiting

1. Select “Apply” and then .

The settings are applied and the “Administrator Settings” menu exits.

Attention

- The language (English) of the “Administrator Settings” menu cannot be changed.

4-2. Functions of the “Administrator Settings” Menu

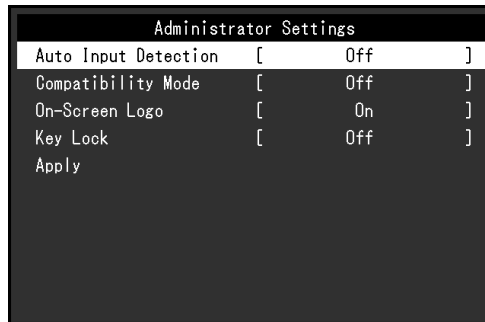

Function	Setting Value	Description
Auto Input Detection	On Off	<p>This function automatically recognizes the connector through which PC signals are input, and displays images on the screen accordingly.</p> <ul style="list-style-type: none"> • “On” When the monitor is connected to multiple PCs, if a specific PC enters power saving mode or no signals are input to the monitor, the connector is automatically changed to another one to which signals are input. • “Off” This function displays the signal from the selected connector regardless of whether a signal is input or not. In this case, you can select the input signal to display using the  operation switch on the front of the monitor. For details, see “2-2. Switching Input Signals” (page 12). <p>Note</p> <ul style="list-style-type: none"> • This product automatically recognizes the connector through which PC signals are input, and displays images on the screen accordingly regardless of whether this function is set to On or Off just after the main power switch on the rear side of the monitor has been turned on. • When this function is set to “On”, the monitor only enters the power saving mode when signals are not input from any PC.
Compatibility Mode	On Off	<p>If you want to avoid the following phenomena, set this function to “On”.</p> <ul style="list-style-type: none"> • The positions of windows and icons are shifted when the monitor is turned off / on or has returned from the power saving mode. • Power Save function of the PC does not work normally. • When the power to the monitor is turned off, a device connected to the USB downstream port does not work.
On-Screen Logo	On Off	<p>When the monitor is turned on, the EIZO logo appears on the screen.</p> <p>When this function is set to “Off”, the EIZO logo does not appear.</p>

Function	Setting Value	Description
Key Lock	Off Menu All	<p>In order to prevent changes to settings, the operation switches on the front of the monitor can be locked.</p> <ul style="list-style-type: none"> • “Off” (default setting) Enables all switches. • “Menu” Locks the  switch. • “All” Locks all switches except the power switch.

Chapter 5 Troubleshooting

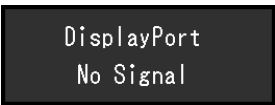
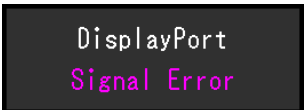

5-1. No Picture

Problem	Possible cause and remedy
<p>1. No picture</p> <ul style="list-style-type: none"> Power indicator does not light up. Power indicator is lighting white. Power indicator is lighting orange. Power indicator is flashing orange and white. 	<ul style="list-style-type: none"> Check whether the power cord is connected properly. Turn on the main power switch on the rear side of the monitor. Touch . Turn off the main power switch on the rear side of the monitor, and then turn it on again a few minutes later. Increase “Brightness”, “Contrast”, or “Gain” in the Setting menu (see “Color Adjustment” (page 17)). Switch the input signal. Turn the setting “On” for “Compatibility Mode” on the “Administrator Settings” menu (see “Compatibility Mode” (page 26)). Move the mouse or press any key on the keyboard. Check whether the PC is turned on. Turn off the main power switch on the rear side of the monitor, and then turn it on again. This symptom may occur during DisplayPort input. Use a signal cable recommended by us for the connection. Turn the monitor off and on.
<p>2. The message below appears.</p> <ul style="list-style-type: none"> This message appears when no signal is input. Example:  The message shows that the input signal is out of the specified frequency range. Example:  	<p>This message appears when the signal is not input correctly even though the monitor is functioning properly.</p> <ul style="list-style-type: none"> The message shown left may appear, because some PCs do not output the signal immediately after power-on. Check whether the PC is turned on. Check whether the signal cable is connected properly. Switch the input signal. Turn off the main power switch on the rear side of the monitor, and then turn it on again. Check whether the PC is configured to meet the resolution and vertical scan frequency requirements of the monitor (see “1-3. Supported Resolutions” (page 10)). Reboot the PC. Select an appropriate setting using the graphics board’s utility. Refer to the User’s Manual of the graphics board for details.

5-2. Imaging Problems (Both Digital and Analog)

Problem	Possible cause and remedy
1. The screen is too bright or too dark.	<ul style="list-style-type: none"> Use "Brightness" or "Contrast" in the Setting menu to adjust it (see "Color Adjustment" (page 17)). (The LCD monitor backlight has a limited life span. If the screen becomes dark or begins to flicker, contact your local EIZO representative.) If the screen is too bright, try changing the Auto EcoView setting to "On". The monitor detects the ambient brightness to adjust the screen brightness automatically (see "Auto EcoView" (page 14)).
2. The brightness changes on its own.	<ul style="list-style-type: none"> Try changing the Auto EcoView setting to "Off" (see "Auto EcoView" (page 14)).
3. Text is blurred.	<ul style="list-style-type: none"> Check whether the PC is configured to meet the resolution and vertical scan frequency requirements of the monitor (see "1-3. Supported Resolutions" (page 10)). When an image is displayed with a resolution other than recommended, text or lines in the displayed image may blur. In this case, try adjusting "Sharpness" in the Setting menu (see "Sharpness" (page 21)).
4. Afterimages appear.	<ul style="list-style-type: none"> Afterimages are particular to LCD monitors. Avoid displaying the same image for a long time. Use the screen saver or power saving function to avoid displaying the same image for extended periods of time. Depending on the image, an afterimage may appear even if it was displayed for a short period of time. To remove such a phenomenon, change the image or keep the power turned off for several hours.
5. Green / red / blue / white / dark dots remain on the screen.	<ul style="list-style-type: none"> This is due to LCD panel characteristics and not a malfunction.
6. Interference patterns or pressure marks remain on the LCD panel.	<ul style="list-style-type: none"> Leave the monitor with a white or black screen. The symptom may disappear.
7. Noise appears on the screen.	<ul style="list-style-type: none"> In the Setting menu, set "Overdrive" to "Off" (see "Overdrive" (page 19)). When inputting HDCP system signals, normal images may not be displayed immediately.
8. The positions of windows and icons are shifted when the monitor is turned off / on or when restored from power saving mode.	<ul style="list-style-type: none"> Turn the setting "On" for "Compatibility Mode" on the "Administrator Settings" menu (see "Compatibility Mode" (page 26)).
9. The color shown on the screen is not correct.	<ul style="list-style-type: none"> Try changing "Input Color Format" in the Setting menu (see "Input Color Format" (page 21)).
10. Images are not displayed over the entire area of the screen.	<ul style="list-style-type: none"> Try changing "Picture Expansion" in the Setting menu (see "Picture Expansion" (page 20)).

5-3. Imaging Problems (For Analog Only)

Problem	Possible cause and remedy
<p>1. Display position is incorrect.</p> 	<ul style="list-style-type: none">• Use “Position” in the Setting menu to correct the image position (see “Hor. Position”, “Ver. Position” (page 22)).• If the problem persists, use the graphics board’s utility if available to change the display position.
<p>2. Vertical bars appear on the screen or a part of the image is flickering.</p> 	<ul style="list-style-type: none">• Use “Clock” in the Setting menu to adjust it (see “Clock” (page 22)).
<p>3. Whole screen is flickering or blurring.</p> 	<ul style="list-style-type: none">• Use “Phase” in the Setting menu to adjust it (see “Phase” (page 22)).

5-4. Other Problems

Problem	Possible cause and remedy
1. The Setting menu does not appear.	<ul style="list-style-type: none"> • Check whether the switch operation lock function is active (see “Key Lock” (page 27)).
2. Cannot select items in the Setting menu.	<ul style="list-style-type: none"> • Items that are displayed with gray text cannot be changed.
3. No audio output.	<ul style="list-style-type: none"> • Check whether the stereo mini jack cable is properly connected to the stereo mini jack (). • Check whether volume is set to 0. • Check the PC and audio playback software to see whether they are configured correctly. • For DisplayPort input and HDMI input, check the settings for “Sound Source” (refer to “Sound Source” (page 21)).
4. USB devices connected to the monitor do not work.	<ul style="list-style-type: none"> • Check whether the USB cable is correctly connected between the PC and the monitor (see “7-2. Using the USB Hub Function” (page 38)). • Check whether the USB cable is correctly connected between the peripheral and the monitor. • Try using a different USB port on the monitor. • Try using a different USB port on the PC. • Reboot the PC. • When “Compatibility Mode” is set to “Off” in the “Administrator Settings” menu and the power of the monitor is turned off, devices connected to the USB downstream port are not operational. Change the setting for “Compatibility Mode” to “On” (refer to “Compatibility Mode” (page 26)). • If the peripheral devices work correctly when they are directly connected to the PC, contact your local EIZO representative. • Depending on the USB 3.1 Gen 1 host controller you are using, the connected USB device may not be recognized properly. Update to the latest USB 3.1 Gen 1 driver provided by the manufacturer, or connect the monitor to the USB 2.0 port. • Check the PC’s BIOS setting for USB when using Windows. (Refer to the manual of the PC for details.)
5. The USB hub function cannot be used.	<ul style="list-style-type: none"> • When “Compatibility Mode” is set to “Off” in the “Administrator Settings” menu and the power of the monitor is turned off, the USB hub function cannot be used. Change the setting for “Compatibility Mode” to “On” (refer to “Compatibility Mode” (page 26)).
6. Power indicator is flashing orange and white.	<ul style="list-style-type: none"> • This symptom may occur when the PC is connected to the DisplayPort connector. Use a signal cable recommended by us for the connection. Turn the monitor off and on. • Check the connection and condition of the USB devices connected to the monitor. • Turn off the main power switch on the rear side of the monitor, and then turn it on again.
7. Power Save function of the PC does not work normally.	<ul style="list-style-type: none"> • Turn the setting “On” for “Compatibility Mode” on the “Administrator Settings” menu (see “Compatibility Mode” (page 26)).

Chapter 6 Attaching/Removing the Stand

6-1. Removing the Stand

The stand section of this product can be removed.

Attention

- Do not move the stand up and down after removing it. If you move the stand up and down while it is not attached to the monitor, this may cause damage or injury.
- If you drop the monitor or stand, this may cause damage or injury due to the weight of the monitor and stand.

1. Raise the height of the monitor to the maximum height.

Attention

- If the monitor is not raised to the maximum height, there may be cases when the height of the monitor accidentally changes while removing the stand. This may be the cause of injury or damage.

2. Lay the LCD monitor on a soft cloth spread over a stable and flat surface with the LCD panel surface facing down.

3. Remove the stand.

As shown in the diagram, press the lock button (1) while holding firmly onto the support section of the stand, and slide the stand in the direction of the pedestal on the bottom (2). Next, pull the stand upwards to remove it (3).

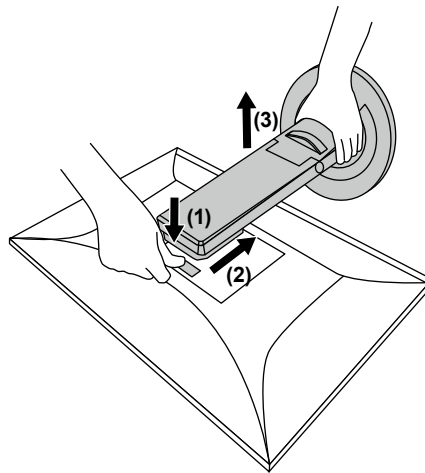



6-2. Attaching the Optional Arm

An optional arm (or an optional stand) can be attached by removing the stand section. Please refer to our web site for the supported optional arm (or optional stand). www.eizoglobal.com

Attention

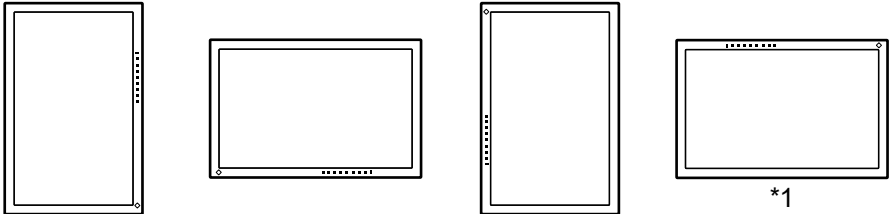
- When attaching an arm or stand, follow the instructions of the respective User's Manual.
- When using another manufacturer's arm or stand, confirm the following in advance and select one conforming to the VESA standard. Use the VESA mounting screws supplied with this product when attaching the arm or stand.
 - Clearance between screw holes: 100 mm × 100 mm
 - VESA mount of the arm or stand, external dimensions: 122 mm x 122 mm or less
 - Plate thickness: 2.6 mm
 - Strong enough to support weight of the monitor unit (excluding the stand) and attachments such as cables.
- When attaching an arm or stand, the installable orientations and movement range (tilt angle) are as follows:

Orientation	
Movement range (tilt angle)	 <p>Up: 45°</p> <p>Down: 45°</p>

*1 If you position the monitor facing in this direction, clean the power connector and the surrounding area regularly. If dust, water, oil, or other materials adhere to the device, it can cause a fire.

- Connect the cables after attaching an arm or stand.
- Do not move the removed stand up and down. Doing so may result in injury or device damage.
- The monitor, arm, and stand are heavy. Dropping them may result in injury or equipment damage.
- Check periodically that the screws are tight enough. If the screws are not tight enough, the monitor may come unattached. This may be the cause of injury or damage.

1. Attach the arm or stand to the monitor.

Use the VESA mounting screws supplied with this product when attaching the arm or stand.

6-3. Attaching the original stand

- 1.** Lay the LCD monitor on a soft cloth spread over a stable and flat surface with the LCD panel surface facing down.
- 2.** Remove the fixing screws on the optional arm (or optional stand), and detach the optional arm (or optional stand).
- 3.** Attach the original stand.

Insert the four tabs on the stand into the four holes on the back panel (1), and slide the stand towards the upper portion of the monitor (2). The stand clicks when it is attached correctly.

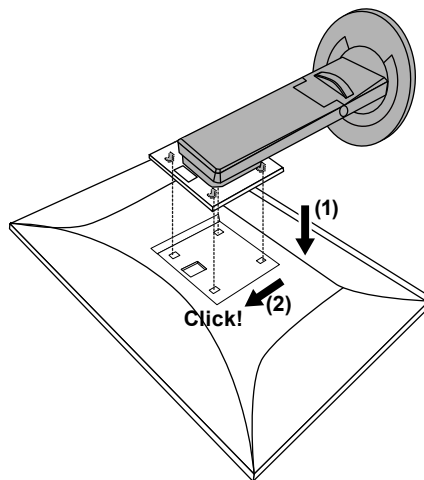

6-4. Removing the Stand Base

The stand base that was attached during setup can be detached using the following procedures.

1. Lay the LCD monitor on a soft cloth spread over a stable and flat surface with the LCD panel surface facing down.
2. Raise the lever on the bottom of the stand base.

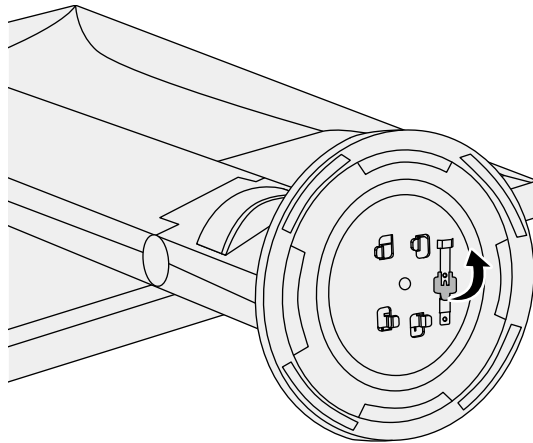

3. Turn the stand base in the counterclockwise direction to detach it.

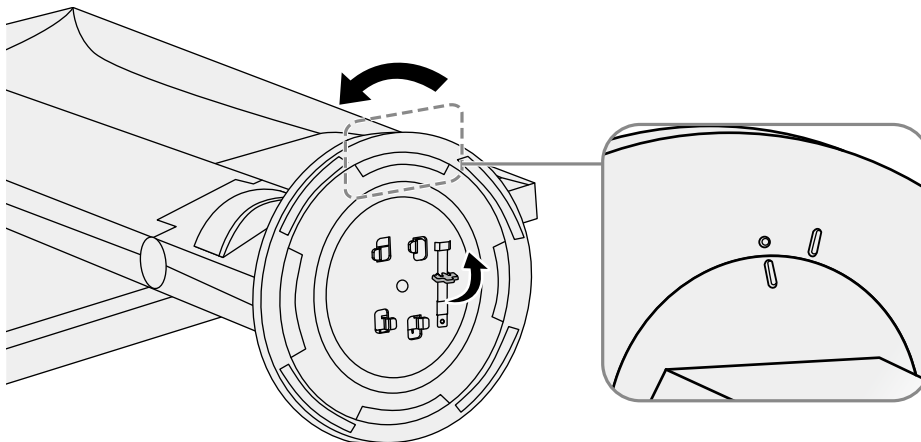

6-5. Attaching the Stand Base

The once removed the stand base can be attached to the monitor again with the following procedures.

1. Lay the LCD monitor on a soft cloth spread over a stable and flat surface with the LCD panel surface facing down.

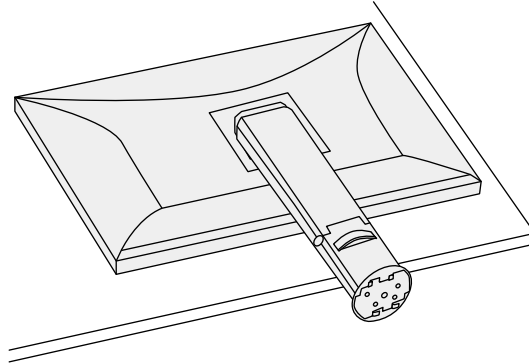

2. Hold the stand base so that the back label (FRONT) is aligned as shown in the diagram, and attach the stand base onto the stand brace.

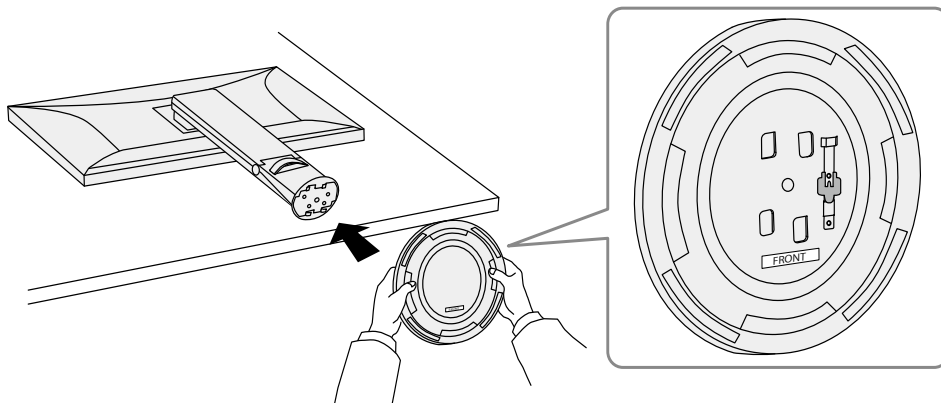

3. Turn the stand base clockwise until it makes a clicking sound.

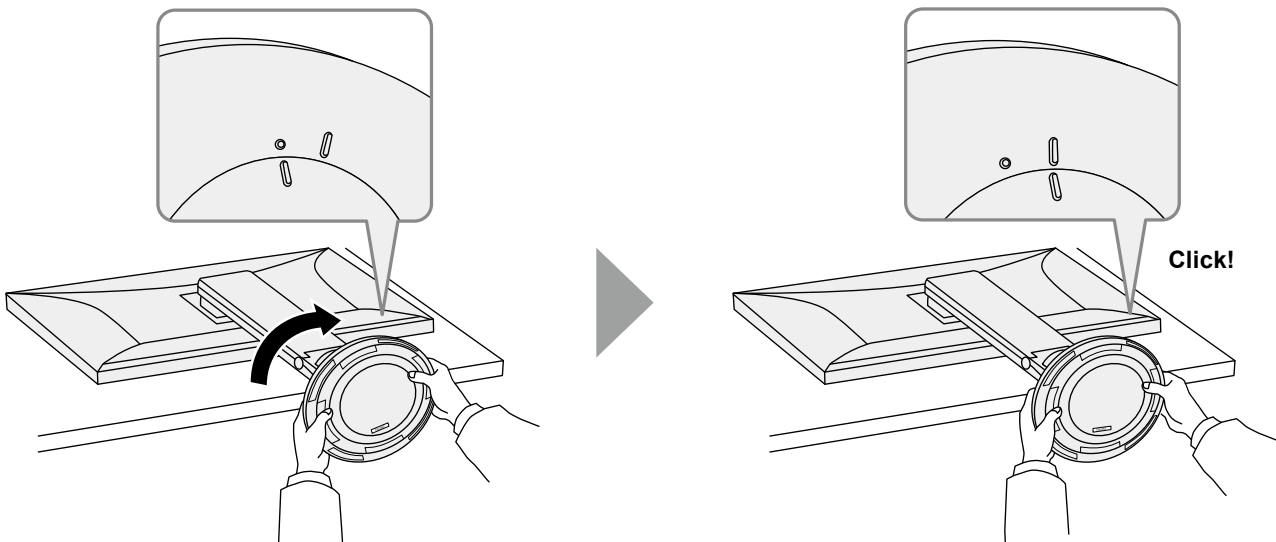

Chapter 7 Reference

7-1. Connecting Multiple PCs

This product can be connected to multiple PCs and allows you to switch between the connections for display.

● Connection examples

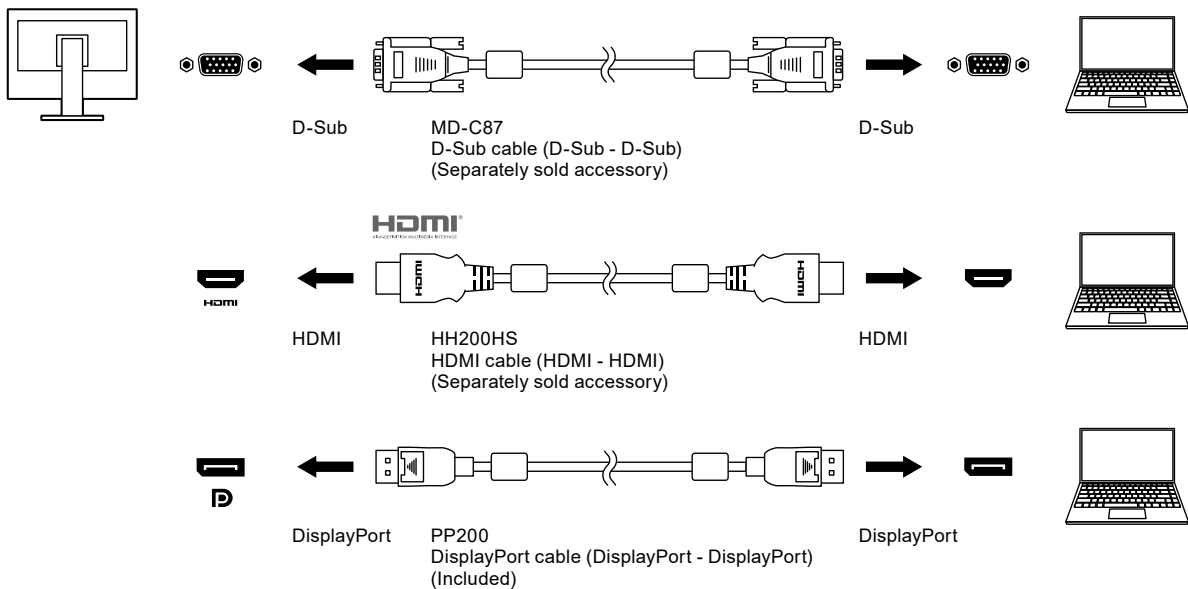

Note

- You can select the input signal to display using the  operation switch on the front of the monitor. For details, see [“2-2. Switching Input Signals” \(page 12\)](#).
- This product provides a function that automatically recognizes the connector through which PC signals are input, and displays images on the screen accordingly. For details, see [“Auto Input Detection” \(page 26\)](#).

7-2. Using the USB Hub Function

This monitor is equipped with a USB hub. It functions as a USB hub when connected to a USB-compatible PC, allowing the connection of peripheral USB devices.

● Connection procedure

1. Connect the USB downstream port of the computer and the USB upstream port of the monitor with a USB cable.

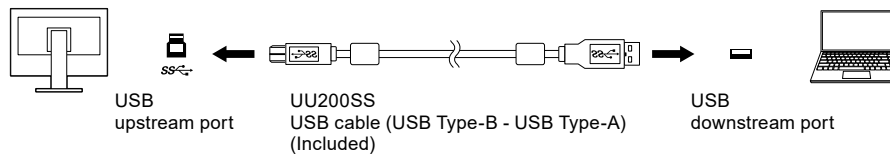

2. Connect a peripheral USB device to the USB downstream port ([page 9](#)) of the monitor.

Attention

- This function may not work depending on the computer you are using, your OS and your peripheral devices. Contact the manufacturer of each device for information about USB compatibility.
- Even when the monitor is in power saving mode, devices connected to the USB downstream port are operational. Due to this, the power consumption of the monitor varies depending on the connected devices, even in power saving mode.
- When the main power of the monitor is off, a device connected to the USB downstream port will not operate.
- When "Compatibility Mode" ([page 26](#)) is set to "Off" and the power to the monitor is turned off, a device connected to the USB downstream port will not work.

Note

- This product supports USB 3.1 Gen 1. When connecting to peripheral devices that support USB 3.1 Gen 1, high-speed data communication is possible (only if the USB cable connecting the external device or peripheral device supports USB 3.1 Gen 1).

7-3. Specifications

LCD Panel	Type	IPS (Anti-Glare)	
	Backlight	LED	
	Size	57.2 cm (22.5 inch)	
	Resolution	1920 dots × 1200 lines	
	Display Size (H × V)	488.2 mm × 297.2 mm	
	Pixel Pitch	0.254 mm × 0.248 mm	
	Display Colors	8-bit colors:	16.77 million colors
	Viewing Angle (H / V, typical)	178° / 178°	
	Response Time (typical)	Gray-to-gray:	14 ms (overdrive setting: Off) 5 ms (overdrive setting: Enhanced)
Video Signals	Input Terminals	DisplayPort (HDCP) × 1, HDMI (HDCP) ^{*1} × 1, D-Sub mini 15-pin × 1	
	Digital Scanning Frequency (H / V)	DisplayPort:	31 kHz to 75.5 kHz / 59 Hz to 61 Hz, 69 Hz to 71 Hz (at 720 × 400)
		HDMI:	31 kHz to 75.5 kHz / 49 Hz to 61 Hz, 69 Hz to 71 Hz (at 720 × 400)
	Analog Scanning Frequency (H / V)	D-Sub:	31 kHz to 75.5 kHz / 59 Hz to 61 Hz, 69 Hz to 71 Hz (at 720 × 400)
	Frame Synchronization Mode	49.0 Hz to 61.0 Hz	
	Max. Dot Clock	162.0 MHz	
USB	Port	Upstream × 1 Downstream × 2	
	Standard	USB Specification Revision 3.1 Gen 1	
	Communication Speed	5 Gbps (super), 480 Mbps (high), 12 Mbps (full), 1.5 Mbps (low)	
	Supply Current	Downstream	Max. 900 mA / 1 port
Audio	Audio Input Format	DisplayPort:	2ch linear PCM (32 kHz / 44.1 kHz / 48 kHz / 88.2 kHz / 96 kHz / 176.4 kHz / 192 kHz)
		HDMI:	2ch linear PCM (32 kHz / 44.1 kHz / 48 kHz / 88.2 kHz / 96 kHz / 176.4 kHz / 192 kHz)
	Speakers	1 W + 1 W	
	Headphones	2 mW + +2 mW (32 Ω)	
	Input Terminals	Stereo mini jack × 1	
		DisplayPort × 1, HDMI × 1 (each shared with video signal)	
	Output Terminals	Headphone jack × 1	
Power	Input	100 - 240 VAC ±10 %, 50 / 60 Hz 0.65 A - 0.35 A	
	Maximum Power Consumption	37 W or less	
	Power Save Mode	0.5 W or less (no USB device connected, default settings)	
	Standby Mode	0.5 W or less (no USB device connected, default settings)	

Physical Specifications	Dimensions	499.0 mm × 340.4 mm to 455.0 mm × 258.9 mm to 271.4 mm (W × H × D) (Tilt: 35°)
		499.0 mm × 333.9 mm to 473.9 mm × 233.0 mm (W × H × D) (Tilt: 0°)
	Dimensions (Without Stand)	499.0 mm × 321.3 mm × 53.6 mm (W × H × D)
	Net Weight	Approx. 5.5 kg
	Net Weight (Without Stand)	Approx. 3.4 kg
	Height Adjustment Range	140 mm (Tilt: 35°) / 140 mm (Tilt: 0°)
	Tilt	Up 35°, down 5°
	Swivel	344°
Vertical Rotation	Left 90°, right 90°	
Operating Environmental Requirements	Temperature	5 °C to 35 °C
	Humidity	20 % to 80 % R.H. (no condensation)
	Air Pressure	540 hPa to 1060 hPa
Transportation / Storage Environmental Requirements	Temperature	-20 °C to 60 °C
	Humidity	10 % to 90 % R.H. (no condensation)
	Air Pressure	200 hPa to 1060 hPa

*1 HDMI CEC (or mutual control) is not supported.

● Accessories

For the latest information about accessories, refer to our web site www.eizoglobal.com.

Appendix

Trademark

The terms HDMI and HDMI High-Definition Multimedia Interface, and the HDMI Logo are trademarks or registered trademarks of HDMI Licensing, LLC in the United States and other countries.

The DisplayPort Compliance Logo and VESA are registered trademarks of the Video Electronics Standards Association.

The SuperSpeed USB Trident Logo is a registered trademark of USB Implementers Forum, Inc.



The USB Power Delivery Trident Logos are trademarks of USB Implementers Forum, Inc.



DICOM is the registered trademark of the National Electrical Manufacturers Association for its standards publications relating to digital communications of medical information.

Kensington and Microsaver are registered trademarks of ACCO Brands Corporation.

Thunderbolt is a trademark of Intel Corporation in the United States and/or other countries.

Microsoft and Windows are registered trademarks of Microsoft Corporation in the United States and other countries.

Adobe is a registered trademark of Adobe Systems Incorporated in the United States and other countries.

Apple, macOS, Mac OS, OS X, Macintosh and ColorSync are registered trademarks of Apple Inc.

ENERGY STAR is a registered trademark of the United States Environmental Protection Agency in the United States and other countries.

EIZO, the EIZO Logo, ColorEdge, CuratOR, DuraVision, FlexScan, FORIS, RadiCS, RadiForce, RadiNET, Raptor and ScreenManager are registered trademarks of EIZO Corporation in Japan and other countries.

ColorEdge Tablet Controller, ColorNavigator, EcoView NET, EIZO EasyPIX, EIZO Monitor Configurator, EIZO ScreenSlicer, G-Ignition, i•Sound, Quick Color Match, RadiLight, Re/Vue, SafeGuard, Screen Administrator, Screen InStyle, ScreenCleaner and UniColor Pro are trademarks of EIZO Corporation.

All other company names, product names, and logos are trademarks or registered trademarks of their respective companies.

License

The bitmap font used for this product is designed by Ricoh Industrial Solutions Inc.

